

OPERATION AND MAINTENANCE MANUAL

Model 475 Power Unit





OPERATION / MAINTENANCE MANUAL

MODEL 475 POWER UNIT

7032 SOUTH 196th - KENT, WA. 98032 - (253) 872-0141 / FAX (253) 872-8710

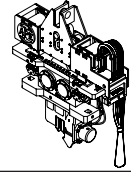

V. MAINTENANCE (Continued...)

V-7A. Power Unit - Filters, Fluid Types and Capacities. (Table 5-A.)

FILTERS

LOCATION	ENGINE	FILTER TYPE	QUANTITY
Engine Oil:	CATC-13	1R-1808	1 each
Engine Fuel/Water Sep	CATC-13	1R-0771	1 each
Engine Fuel Filter	CATC-13	1R-0751	1 each
Air Filter, Outer:	CATC-13	132-7167	1 each
Air Filter, Inner	CATC-13	61-2510	1 each
Hydraulic Oil Filters:	Zinga	ZLE-10	2 each
Hand Pump Filter:	Zinga	AE-25	1 each

ENGINE OIL TYPES AND CAPACITIES

LOCATION	ENGINE	OIL TYPE	CAPACITY
Hydraulic Oil-Main:	-----	Mobil EAL 224 Veg.	300 gal/1150 L
Hyd Oil-Reserve:	-----	Mobil EAL 224 Veg.	55 gal/208 L
Engine Oil:	CAT C13	DEO or APICH-4	40 quarts/38 L
Engine Water:	-----	50/50 Water/Gyicol	27 gal/103 L
Fan Drive:	-----	Multi-Purpose Grease	
Governor Control:	-----	Multi-Purpose Grease	
GearBox:	-----	84 ounces 90W or Synthetic Mobil SHC 629	
Pump pad		8 ounces of 90W or Mobil SHC 629	
Pump flange (between engine and drive)		8 ounces of 90W or Mobil SHC 629	

- Check water level in radiator
- Check battery level
- Check fuel level
- Check oil level in pump drive
- Check hydraulic oil level

- Check engine oil
- Check hydraulic return filter indicator
- Check fan belts on engine
- Check entire unit for hydraulic leaks
- Check condition of jaws before operating

See page 5-7B for details on lubrication of the pump drive and its components.



OPERATION / MAINTENANCE MANUAL

MODEL 475 POWER UNIT

7032 SOUTH 196th - KENT, WA. 98032 - (253) 872-0141 / FAX (253) 872-8710

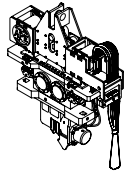

V. MAINTENANCE (Continued...)

V7-B. Power Unit - Hydraulic Fluid.

When adding or changing hydraulic fluid APE uses only Mobil 224 Hydraulic Vegetable oil which is non-toxic and will not harm oil or water and is biodegradable. Consult your local oil supplier for recommendations on mixing hydraulic oils. Change hydraulic oil if it looks milky. This includes all hydraulic lines leading to and from the vibro. Milky oil indicates that water is in the oil.

V7-C. Power Unit - Draining and Filling Hydraulic Fluid Tank

1. Remove plug located on bottom of tank
2. Refill by manually pumping with hand crank.
3. Prime both the clamp and the main pump before restarting.
4. Take extreme caution that no dirt or other unwanted particles enters the system.

V7-D. Power Unit - Cleaning Hydraulic Tank Suction Filter. (No suctions on 1993 and newer)

1. Located inside the hydraulic tank or reservoir, is a suction filter.
2. Drain tank.
3. Remove side cover.
4. Reach into to and unscrew filter from pipe fitting.
5. Clean with solvent and re-install. If damaged then replace.
6. Re-install filter.
7. Re-install tank cover.
8. Add new oil to tank.
9. Prime pumps.



OPERATION / MAINTENANCE MANUAL

MODEL 475 POWER UNIT

7032 SOUTH 196th - KENT, WA. 98032 - (253) 872-0141 / FAX (253) 872-8710

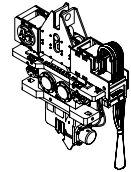

V. MAINTENANCE (Continued...)

V-7E. Power Unit - Changing Hydraulic Return Filter Element.

The hydraulic return filter is mounted on the hydraulic tank inside the power unit. It is mounted high on the tank so that when the filter element is removed the oil will not drain from the hydraulic tank. The filter has a manual pop-up type indicator to tell when the filter is dirty. The pop-up indicator turns red when it is in the dirty position or when the return filter gauge reads 50 PSI and when the hydraulic oil is up to temp.

V-7F. Power Unit - Steps to Remove the Element.

1. Shut down power unit by turning off the diesel engine.
2. Place warning tag on control panel so that no one mistakenly starts the unit while filters are being changed.
3. Clean area around filter so that when it is removed there is no chance of introducing dirt into the hydraulic system.
4. Using a filter wrench, turn the filter counter clockwise and spin the filter off the filter housing.
5. Install new clean filter making sure the o-ring is in place.
6. Depress filter indicator to re-set to "clean position".



OPERATION / MAINTENANCE MANUAL

MODEL 475 POWER UNIT

7032 SOUTH 196th - KENT, WA. 98032 - (253) 872-0141 / FAX (253) 872-8710

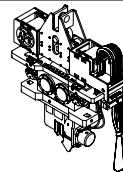

VII. MODEL 475 POWER UNIT

VII-1. Hydraulic Circuitry.

The following are descriptions of the components that make up the Hydraulic Circuitry of the APE Model 475 power unit.

VII-1A. Clamp Circuitry. (Used for extending and retracting jaw cylinder)

Oil for the clamp circuit is provided by item the clamp pump. This pump is a 1.5 cu.in/rev 5000 psi piston pump. All oil to the inlet of this pump is filtered through a suction strainer located in the tank. Clamp oil is then directed from the pump to the clamp directional control valve. When the clamp switch is in the "off" position, the oil flows through the clamp directional control valve and back to the oil tank. When the clamp switch is moved to open, solenoid "A" on the clamp directional control valve is energized the oil will flow out to the clamp cylinder and retract or open the jaws. The clamp open pressure can be seen on the clamp pressure gage located on the panel. When the clamp switch is moved to the closed position, solenoid "B" will be energized and oil flow will be directed to the clamp cylinder. The clamp cylinder will then extend or close the jaws. A Clamp pressure switch item will de-energize solenoid "B", directing pump oil flow back to oil tank. Clamp pressure is maintained in clamp cylinder by a pilot operated check valve. At any time should the clamp pressure fall below 3500 psi. the clamp pressure switch will re-energize solenoid "B" on the clamp control valve, and direct pump flow to the clamp cylinder. Maximum clamp pressure is limited by the clamp pressure relief valve set at 4300 psi. The quick disconnect couplers permit decoupling of clamp hoses.

VII-1B. Drive Circuit. (Used for operating APE vibrator, APE drill or any other unit)

There are two gear pumps that direct oil to the drive circuit (Vibro Motors). The maximum drive pressure is controlled by the drive pressure relief valve, to 4800 psi. max. When the drive switch is moved to the forward position, solenoid "A" of the drive directional control valve is energized. Oil flow is directed to the vibro motors to rotate the eccentrics. When the drive switch is moved to the off position, oil flow is directed back to the tank through the drive directional control valve and solenoid "A" is de-energized. Because of the high oil flow in the drive circuit, APE, Inc. has developed a circuit that eliminates high shock loads. Small internal components located in the drive manifold provide a soft shift feature for the drive directional control valve. A small adjustable snubber valve controls a small shuttle valve through small fixed orifices. The orifices are used to dampen the shifting of spool valve. This provides a soft start/stop of the drive directional control valve preventing hydraulic shock to the drive system. The shuttle valve is used to send a hydraulic signal to the drive pressure relief valve when the drive directional control valve is centered or de-energized. This hydraulic signal tells the drive pressure control valve to open and allow any high flow, high pressure back to tank. The snubber valve simply controls how fast this signal is received by the drive pressure relief valve. The drive pressure can be read on the drive pressure gage item.

The quick-disconnect couplings permit de-coupling of the drive and case drain hoses at the power unit.

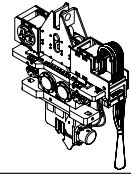

VII. MODEL 475 POWER UNIT (Continued...)

VII-1C. Cooling and Flushing Filter.

The cooling circuit pumps oil through the oil cooler and then through the return filters. This system is called the "Kidney Loop" and is designed to cool the oil and clean the oil in the hydraulic tank. This independent system isolates the return filters from shock associated with the other two circuits, main drive, and clamp.

VII-1D. Oil Cooler.

The oil cooler cools the hydraulic fluid.

VII-1E. Manual Pump.

A manual pump is provided to fill the hydraulic reservoir. A hand valve prevents loss of fluid from the reservoir back through the manual pump.

VII-1F. Hydraulic Oil Temperature.

A temperature gauge indicates hydraulic oil temperature. The sending unit is mounted on the main tank.

Hydraulic Panel

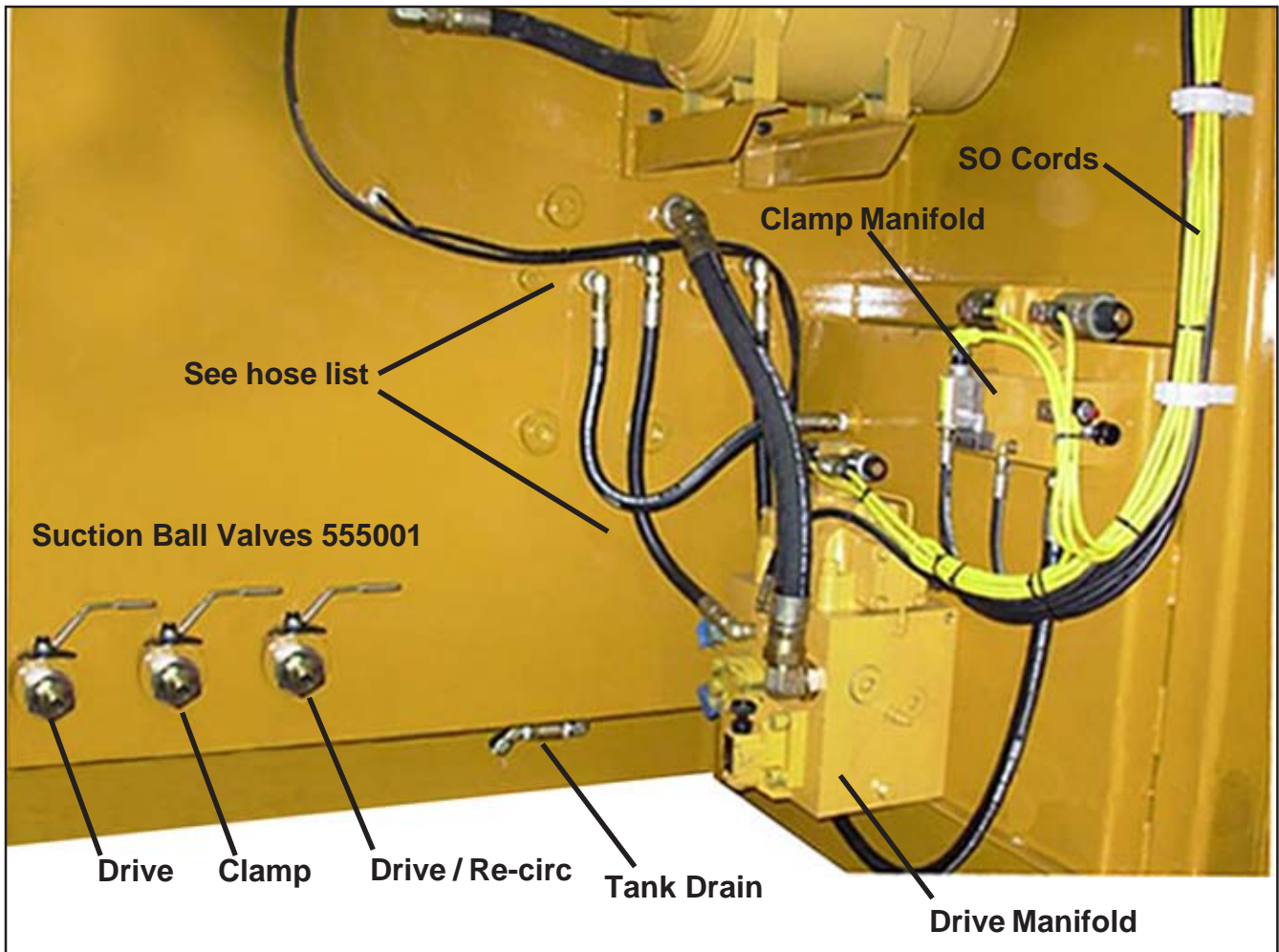

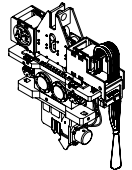

VII. MODEL 475 POWER UNIT (Continued...)

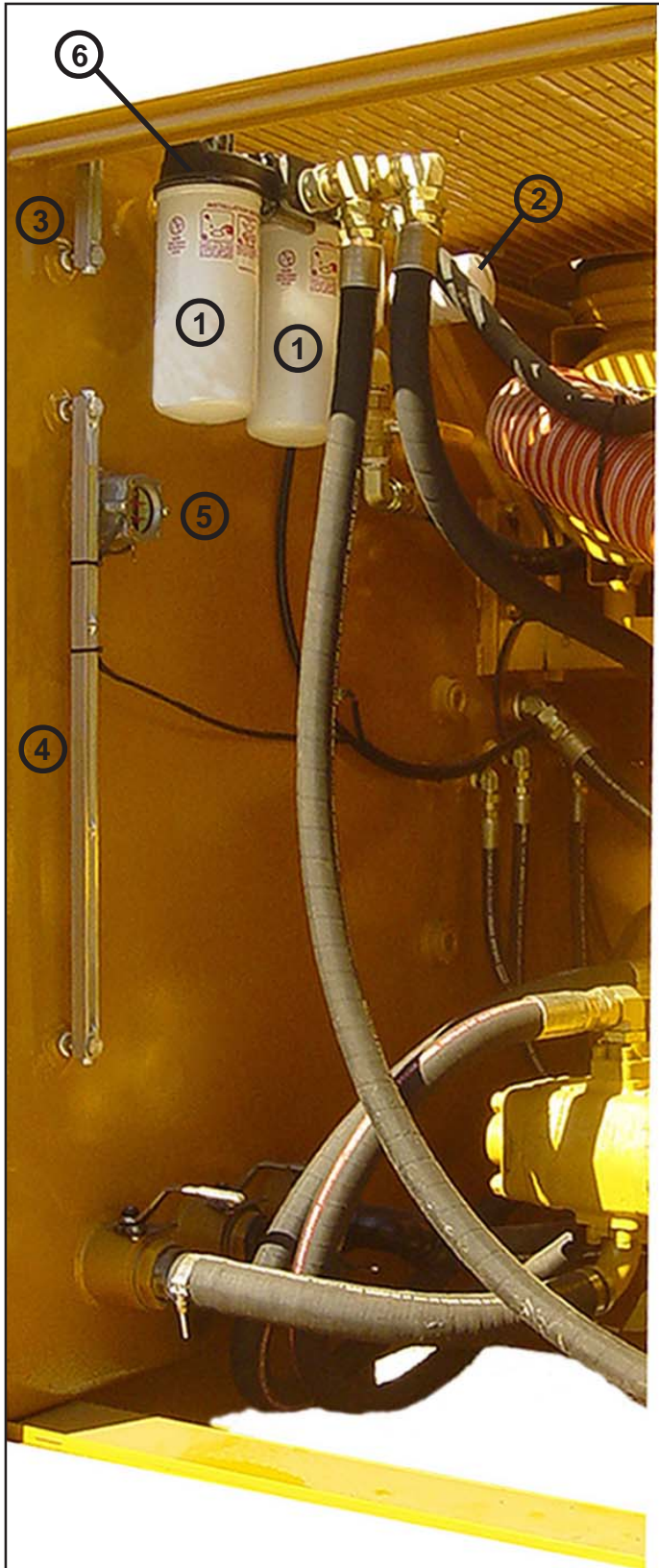

ITEM DESCRIPTION

- 1 Filter Element AE-25
- 2 Breather Element
- 3 6" Sight Gage L/D G607-06-A-1-4
- 4 30" Sight Gage L/D G607-30-A-1-4
- 5 Level Switch L120 (513033)
- 6 Filter Head 25 psi ZAF-10-25-1-3

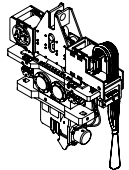

475 POWER UNIT (Continued...)

VII-1G. Hydraulic Components (Continued...)

Hydraulic Components - Clamp / Drill Manifold 523002A

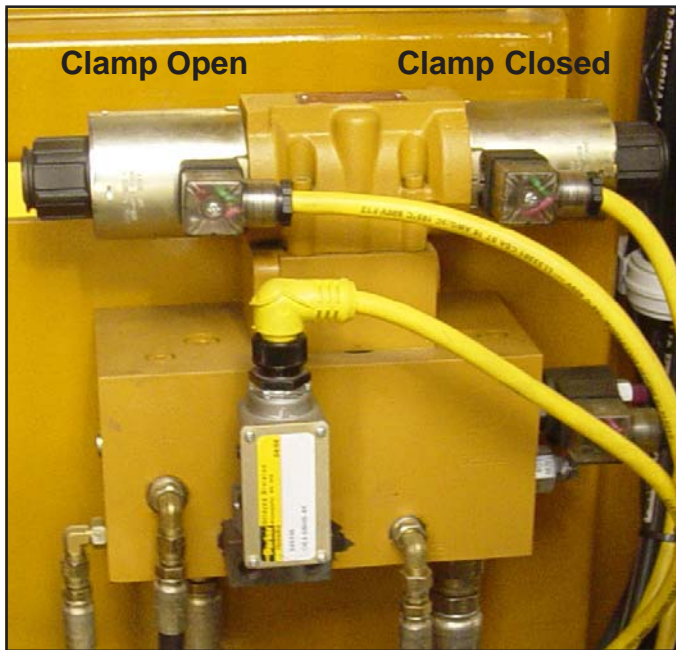

Clamp / Drill Manifold - Rear Panel View

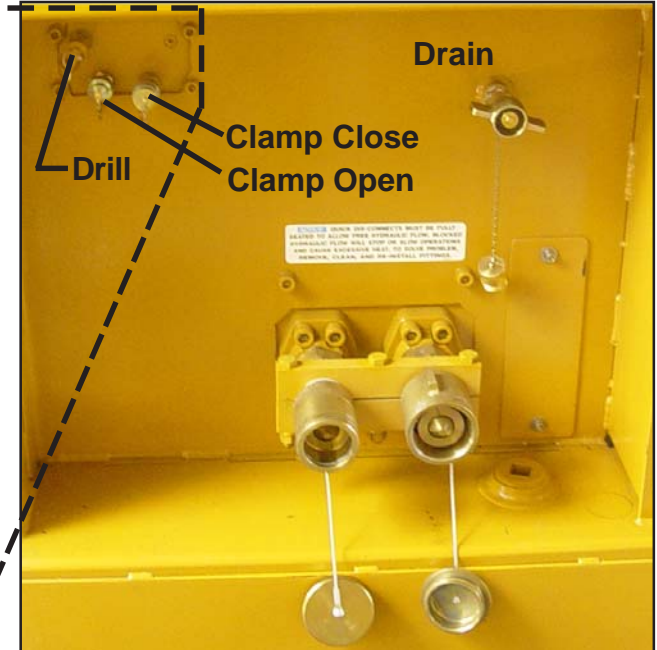

Clamp / Drill Manifold - Front Panel View

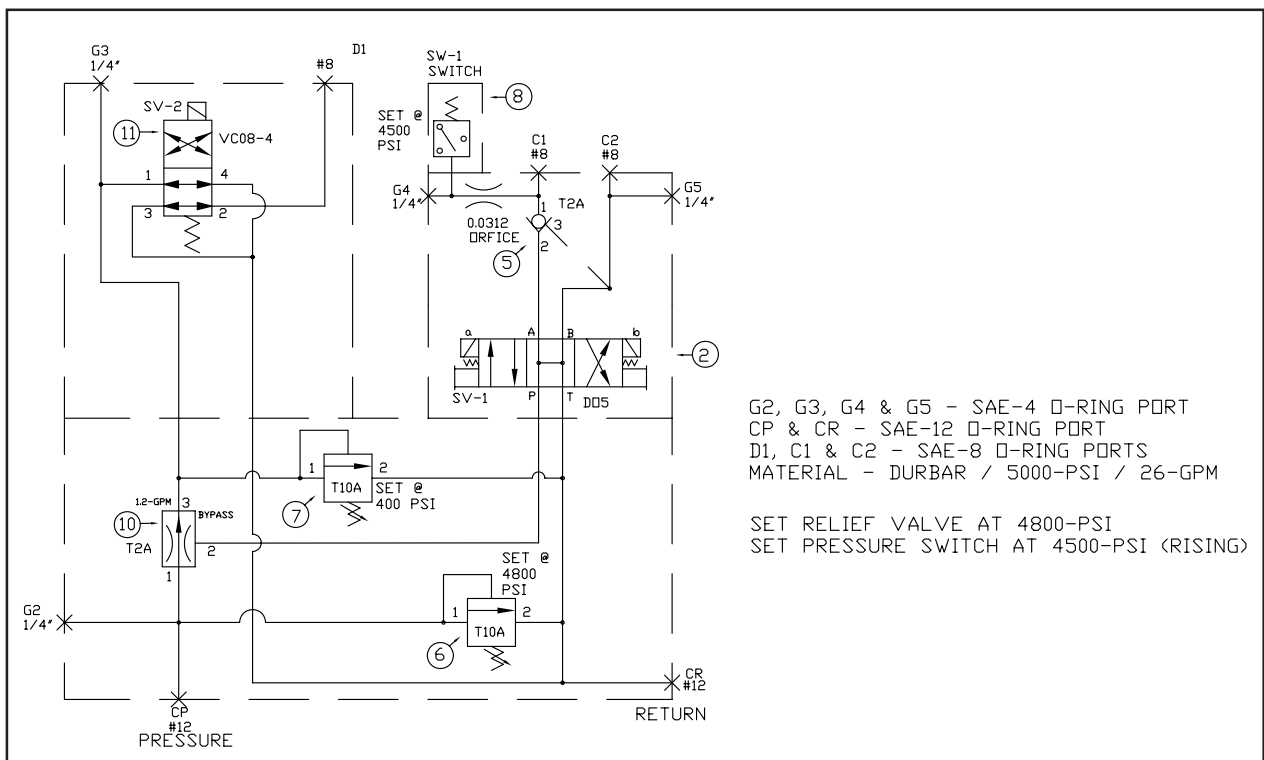

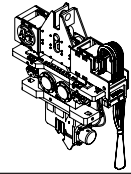

VII-1G. Hydraulic Components (Continued...)

Hydraulic Components - Clamp / Drill Manifold 523002A (Continued...)

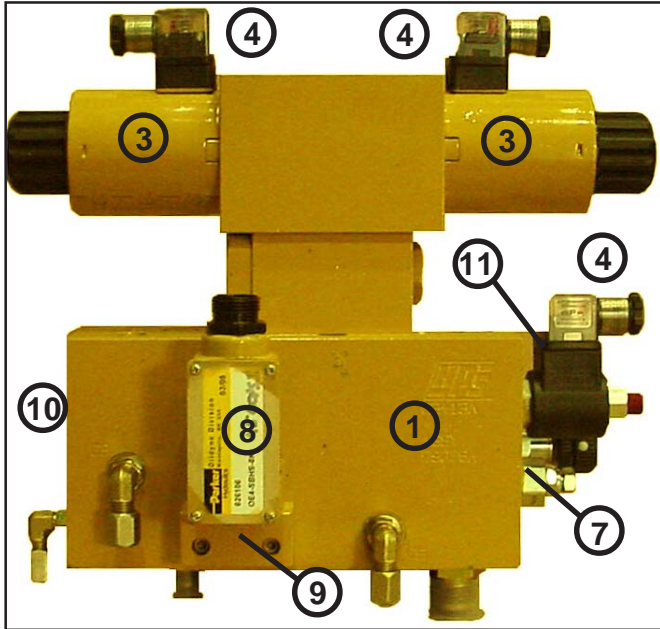

Clamp / Drill Manifold - Rear View

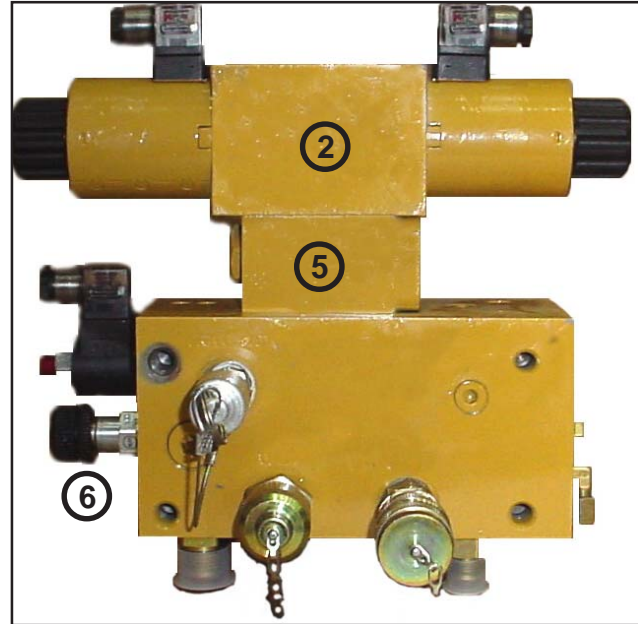

Clamp / Drill Manifold - Front View

<u>Item</u>	<u>Qty</u>	<u>Description</u>	<u>Manufacturer</u>
1	1	Manifold - Machined	Hydra Power D9078A
2	1	Directional Control Valve	Hytos REP3-10311/02400E1
3	2	Coil for D05	Hytos 936-4627
4	3	Lighted DIN Connector	Hytos 936-9907
5	1	PO Check Valve	Sun CKEB-XCN BBA/S
6	1	Relief Valve - Clamp (Set at 4500 psi)	Sun RPEC-KWN
7	1	Relief Valve - Drill (Set at 400 psi)	Sun RPEC-FEN
8	1	Pressure Switch	Oildyne OE4-SBHS-8K
9	1	90 Degree Turn Block	Hydra Power WD022805
10	1	Priority Flow Control (Set at 1.2 GPM)	SunFRDA-XAN
11	1	Solenoid Valve - Drill Shift	Hydraforce SV08-40N-0-24-DG
12	1	Coil - Drill Shift	Hydraforce 6306024

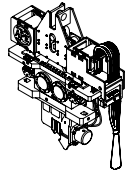

VII. MODEL 475 POWER UNIT (Continued...)

Hydraulic Components - Drive Manifold 513028A



Drive Manifold - Rear View

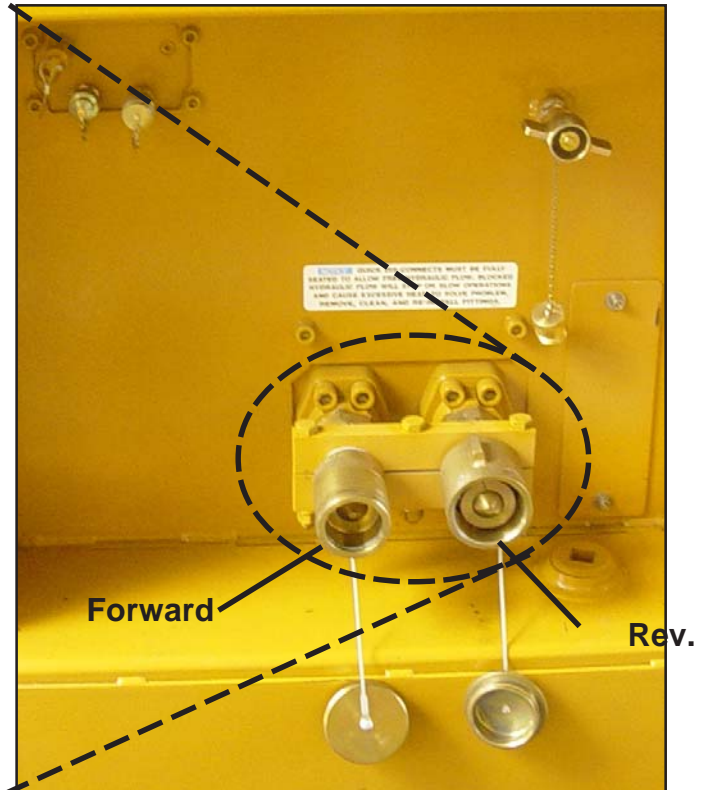

Drive Manifold - Front Panel View

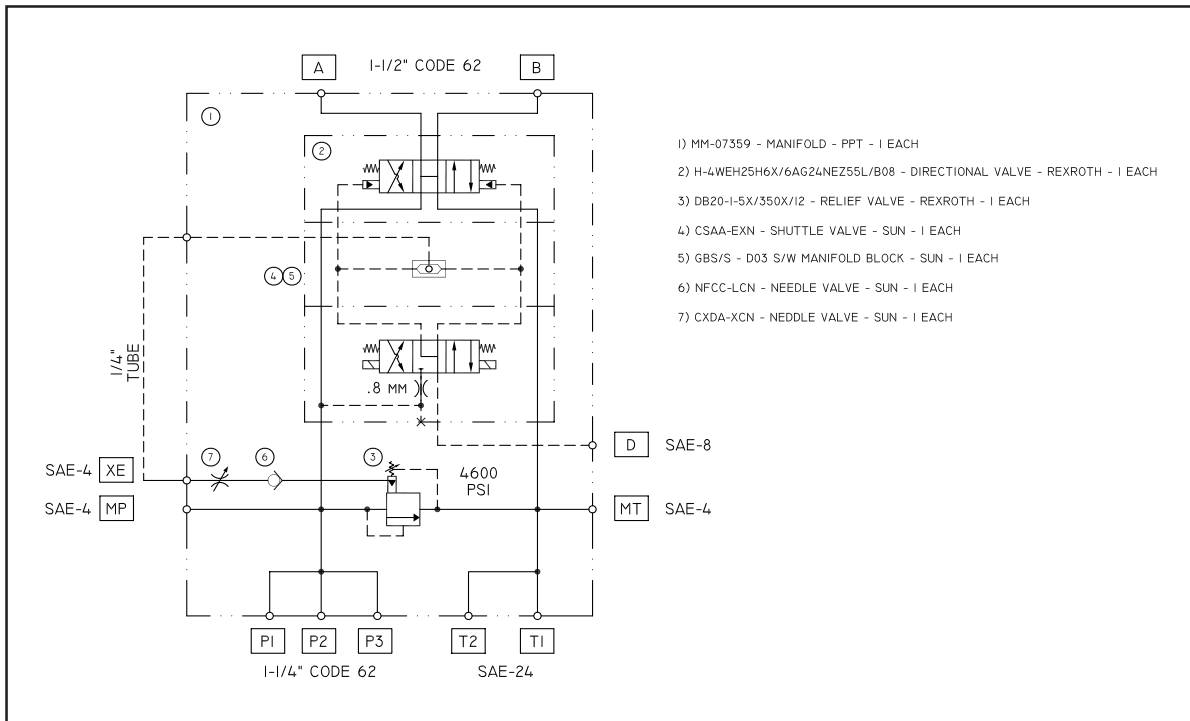

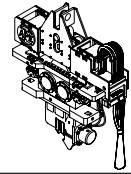

VII. MODEL 475 POWER UNIT (Continued...)

Hydraulic Components - Drive Manifold 513028A (Continued...)

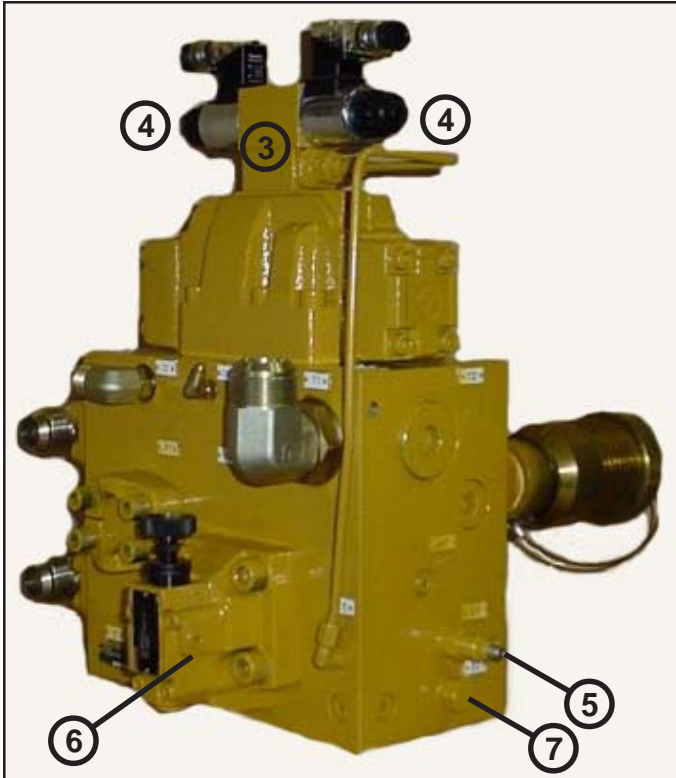

Drive Manifold - Rear View

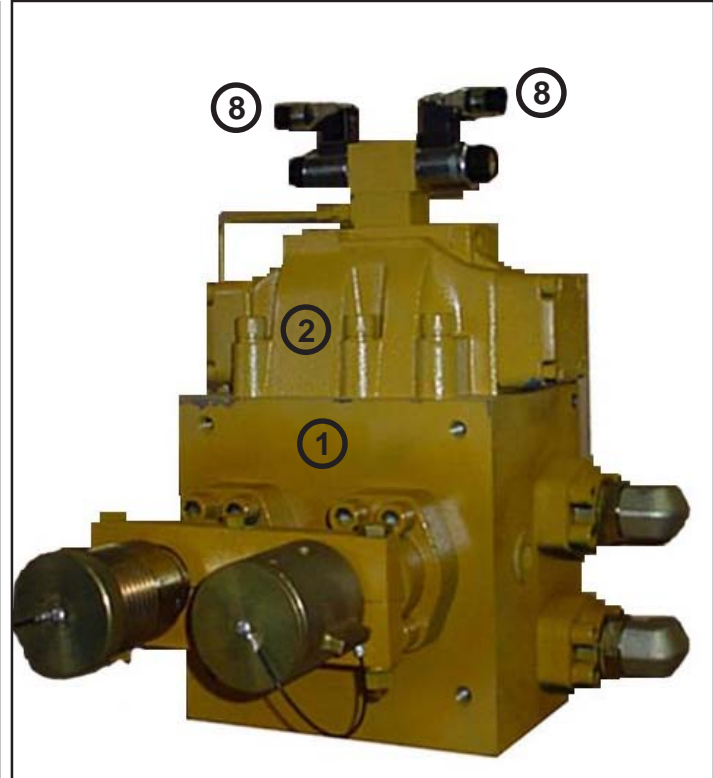

Drive Manifold - Front View

<u>Item</u>	<u>Qty</u>	<u>Description</u>
1	1	Drive Manifold - Machined
2	1	Main Control Valve
3	1	D03 Solenoid Control Valve
4	2	Coil for D03
5	1	Relief Valve
6	1	Needle Valve
7	1	Check Valve
8	2	Lighted DIN Connector

<u>Manufacturer</u>
Pacific Power Tech
Rexroth H4WEH25H64/6EG24NEK4/B08
Rexroth 4WE6M60/EG24NK4/B08
Rexroth R00221884
Rexroth DB20-1-52/350X/12
Sun NFCC-LCN
Sun CKDA-XCN
Rexroth RR00057453 Z55L PLG AB BLK

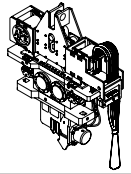

VII. MODEL 475 POWER UNIT (Continued...)

Hydraulic Components - Pump Drive and Pumps

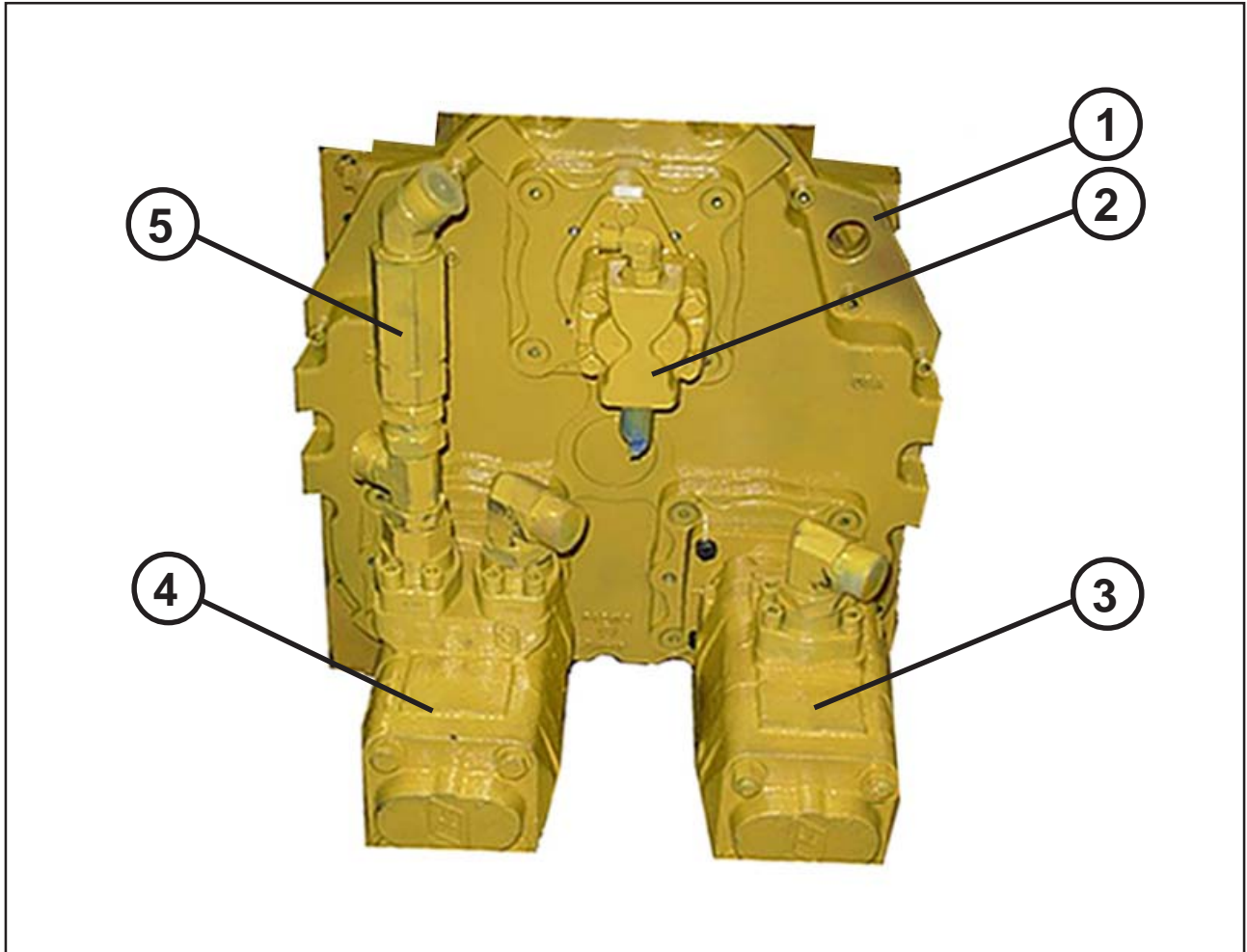

<u>ITEM</u>	<u>DESCRIPTION</u>	<u>APE P/N</u>
1	DURD12463 2-PAD GEARBOX	532051
2	REXROTH CLAMP PUMP	533012
3	COMM. SHEARING DRIVE PUMP	523013
4	COMM. SHEARING DRV/RE-CIRC PUMP	523013
5	CHECK VALVE 1.25	555003

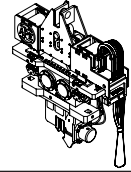

PUMP DRIVE (GEARBOX) LUBRICATION

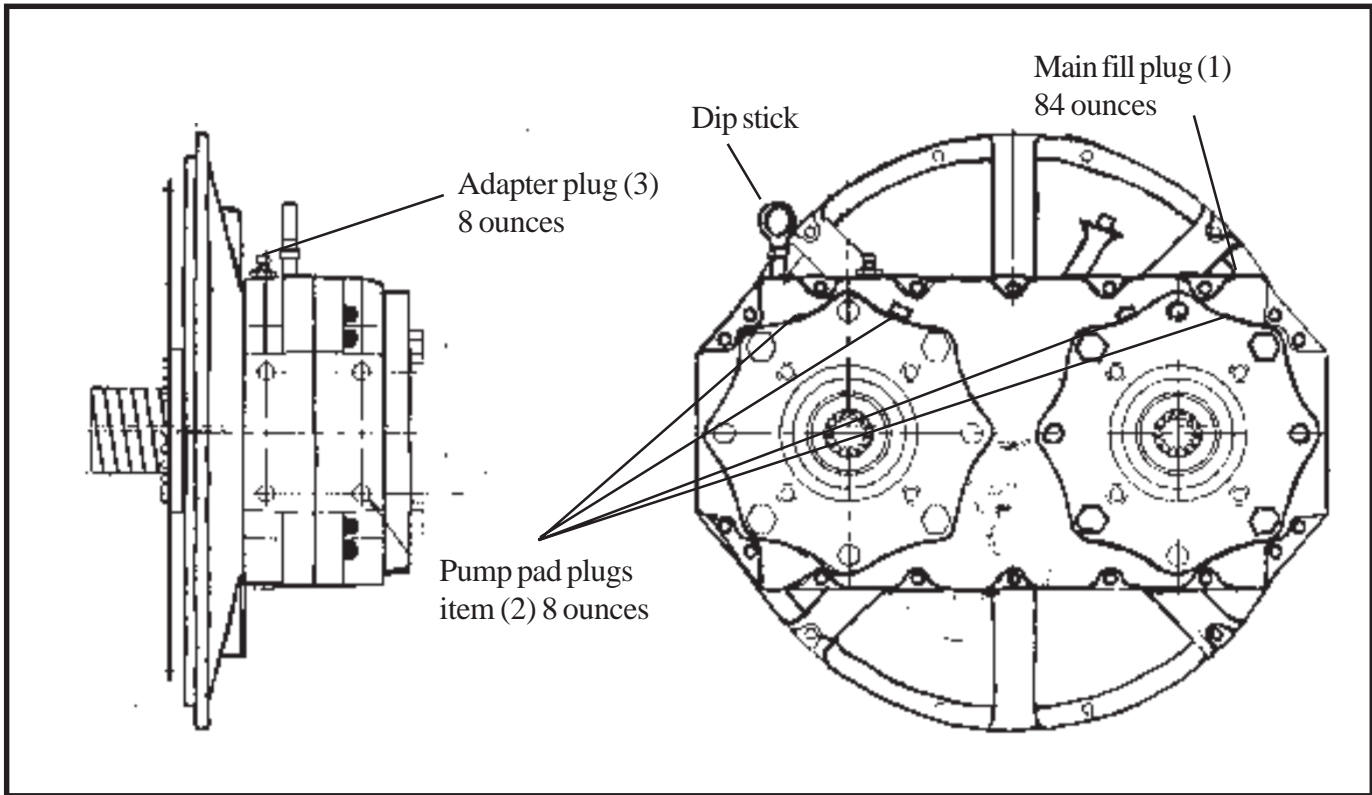

The pump drive used on the APE power units has three areas that require lubrication. The main gearbox takes about 84 ounces of oil. A gallon of oil is 128 ounces, so 88 ounces is just under 3/4 gallon. Check the level using the dip stick. See item 1 for main pump drive reservoir.

The space between the hydraulic pump and the geardrive is not lubricated by the main reservoir. There is a small pipe plug (see item 2 & 3 above) mounted above each pump drive output. Remove this plug and fill this area with 8 ounces of oil. Remember that both pump drive output areas must be filled with 8 ounces of oil. The purpose of this oil is to lubricate the pump shaft and the gear splines on the pump and gear.

The engine adapter must also be lubricated with 8 ounces of oil. This lubricates the main engine shaft and adapter components.

Oil changes are suggested every six months or 1000 hours, which ever occurs first.

Fill with Mobil SHC 629. Before operating the unit, check the oil level dip stick.



OPERATION / MAINTENANCE MANUAL

MODEL 475 POWER UNIT

7032 SOUTH 196th - KENT, WA. 98032 - (253) 872-0141 / FAX (253) 872-8710

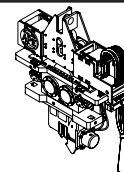

VII. MODEL 475 POWER UNIT (Continued...)

VII-1G. Hydraulic Components - Hose List

<u>QTY</u>	<u>DESCRIPTION</u>	<u>USED FOR</u>
1	F471TC0606-4-4-4-139 1/2	DRIVE FWD AND REV GAUGE
1	F471TC0606-4-4-4-231	RETURN FILTER GAUGE
1	F471TC0606-4-4-4-123 1/2	CLAMP OPEN GAUGE
1	F471TC0606-4-4-4-121 1/2	CLAMP CLOSE GAUGE
1	F471TC0606-4-4-4-114	DRILL SHIFT
1	9190606-4-4-4-86	ENGINE OIL PRESSURE
1	F8110606-16-16-16-42	HAND PUMP PRESSURE
1	F8110606-20-20-20-103	HAND PUMP SUCTION
1	F782TC0606-20-20-20-68 1/2	DRIVE PUMP PSI BOTTOM FTG TO RH PUMP
1	F782TC0606-20-20-20-79	DRIVE PUMP PSI TOP FTG TO LEFT PUMP
1	F811-32 23 1/2	DRIVE AND RECIRCULATION SUCTION LEFT
1	F811-32 17 1/2	DRIVE AND RECIRCULATION SUCTION RIGHT
1	F3010606-20-20-20-92 1/2	RECIRCULATION PUMP PRESSURE TO COOLER
1	F3010606-20-20-20-42 1/2	RECIRCULATION PUMP CHECK TO FILTER
1	F3010606-20-20-20-125	COOLER TO RETURN FILTER
1	F8110606-20-20-20-29 1/2	HYDRAULIC TANK TRANSFER
1	F471TC0606-12-12-12-78	CLAMP/DRILL MANIFOLD RETURN
1	F471TC0606-8-8-8-25 1/2	FUEL TANK TO FILTER
1	F471TC0606-6-6-6-67	FUEL RETURN
1	F811-16 36	CLAMP PUMP SUCTION
1	F471TC0606-8-8-8-41 1/2	CLAMP PUMP PRESSURE TO CLAMP MANIFOLD
1	F471TC0606-12-12-12-27 1/2	DRIVE MANIFOLD DRAIN
1	F471TC0606-12-12-12-30	VIBRO CASE DRAIN
1	F3010606-24-24-24-31	DRIVE MANIFOLD RETURN
62"	6" SILICONE AIR HOSE	6" DIA. AIR INTAKE HOSE
2	HSS-64	6" HOSE CLAMP



OPERATION / MAINTENANCE MANUAL

MODEL 475 POWER UNIT

7032 SOUTH 196th - KENT, WA. 98032 - (253) 872-0141 / FAX (253) 872-8710

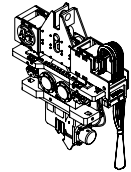

VII. MODEL 475 POWER UNIT (Continued...)

VII-1G. Hydraulic Components - Fittings List

<u>ITEM</u>	<u>QTY</u>	<u>P/N</u>	<u>DESCRIPTION</u>
<u>FUEL TANK AND FUEL INLET FITTINGS</u>			
1	1	16HHP-S	1" HOLLOW HEX PLUG
2	1	6-8-FTX-S	FUEL RETURN
3	1	6-12-CTX-S	FUE L INLET
4	1	STREET ELBOW 1/4 MALLEABLE	FUEL VENT ELBOW
5	1	DC604-4	FUEL VENT VALVE
<u>HYDRAULIC TANK DRAIN FITTINGS</u>			
6	1	16-16-CR-S	
7	1	16-16-VTX-S	
8	1	16-FNTX-S	
9	1	16-V500P	BRASS BALL VALVE
<u>HYDRAULIC TANK FITTINGS</u>			
10	1	20-20 CR-S	TANK TRANSFER FTG
11	1	20-VP500P	LOCKING BALL VALVE TANK TRANSFER
12	2	20-20 CTX-S	TANK TRANSFER FTG
13	3	12-12 CTX-S	
14	1	24-24-VTX-S	MANIFOLD RETURN
15	3	24-HHPS	PLUGS
16	2	12-HHPS	PLUGS
17	1	32-16-F50G5-S	CLAMP PUMP SUCTION
18	1	0588-16-16-S	CLAMP PUMP SUCTION
19	1	L/D G607-06-A-1-4	6" SIGHT GAUGE
20	1	L/D G607-30-A-1-4	30" SIGHT GAUGE
21	1	16-16-FF-S	FILTER HEAD FTG
22	1	16-16-VTX-S	FILTER HEAD FTG
23	1	ZAF-10-25-1-3	FILTER HEAD 25 PSI BYPASS
24	2	AE-25	FILTER ELEMENT
25	1	TB-075	TANK BREATHER ADAPTOR
26	1	12-12-FTX-S	CASE DRAIN COUPLER PANEL
<u>GAUGE AND FITTINGS</u>			
27	3	0-7500PSI GAUGE	25.310.7500/25-3 CFF
28	1	0-100PSI GAUGE	25.310.100/25 CFF
29	1	4-2 DTX-S	CLAMP DRILL GAUGE
30	4	4-4 DTX-S	DRIVE, CLAMP PRESSURE GAUGE
31	1	150F-4-2	OIL PRESSURE GAUGE BRASS



OPERATION / MAINTENANCE MANUAL

MODEL 475 POWER UNIT

7032 SOUTH 196th - KENT, WA. 98032 - (253) 872-0141 / FAX (253) 872-8710

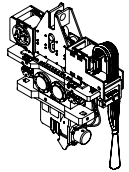

VII. MODEL 475 POWER UNIT (Continued...)

VII-1G. Hydraulic Components - Fittings List

<u>ITEM</u>	<u>QTY</u>	<u>P/N</u>	<u>DESCRIPTION</u>
<u>DRIVE MANIFOLD 513028A</u>			
32	2	W48-32-32-U ALLENS	
33	2	32-24-F50G5-S	
34	2	24-24-F50F-S	
35	2	W48-24-24-U ALLENS	
36	2	20-24-C50X-S	
37	1	4-4-C50X-S	
38	1	12-8-C50X-S	
39	1	24-24-C50X-S	
40	1	24-HP50N-S	
41	1	4-HP50N-S	
42	1	24-FOPX-S	
43	1	HFHFHK-24	
<u>CLAMP/DRILL MANIFOLD 523002A, AND CASE DRAIN</u>			
44	1	8-12-F50X-S	
45	1	12-12-F50X-S	
46	3	4-4-C50X-S	
47	1	4-HP50N-S	
48	1	8-6-F50G-S	
49	2	8-6-F50F-S	
50	1	S35-3 FEMALE	
51	1	S31-3 MALE	
52	1	3005-3 PLUG	
53	1	3009-3 CAP	
54	1	H3-63 NIPPLE	
55	1	H3-66 ALUM CAP	
56	1	12-12-FF-S	
57	1	12-6125	
58	1	12-6109	
<u>RETURN FILTER</u>			
59	1	RETURN FILTER HOUSING	ZDF-2215-50-1-00
60	2	FILTER ELEMENT	ZLE-10
61	1	20-20-C6X-S	
62	1	4-2-CTX-S	GAUGEFTG
63	1	20-20-20-RTX-S	
64	1	20-24-PTR-S	
<u>COOLER</u>			
65	2	20-24-F50X-S	



OPERATION / MAINTENANCE MANUAL

MODEL 475 POWER UNIT

7032 SOUTH 196th - KENT, WA. 98032 - (253) 872-0141 / FAX (253) 872-8710

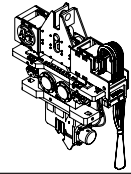

VII. MODEL 475 POWER UNIT (Continued...)

VII-1G. Hydraulic Components - Fittings List

<u>ITEM</u>	<u>QTY</u>	<u>P/N</u>	<u>DESCRIPTION</u>
<u>HAND PUMP</u>			
66	1	20-20-GTX-S	
67	2	SCH 40 1 1/4 X 4LG	
68	1	16-20-CTX-S	
69	1	SPX414 HAND PUMP	
70	1	BR22114	GATE CHECK
<u>CLAMP PUMP</u>			
71	2	HC-100	
72	1	8-12-C50X-S	
73	1	0588-16-16-S	
<u>ENGINE FITTING</u>			
74	1	4-4-4-R6X-S	
75	1	6-6-C6X-S	
76	1	8-3/8-F50G-S MOD 1/4	
<u>DRIVE AND RECIRCULATION PUMPS</u>			
77	3	W46-24-24-U ALLEN	
78	2	20-24-C50X-S	
79	1	24-20-F50G5-S	
80	1	20-20-20-R50X-S	
81	1	20-20-F6X	
82	1	20-20-VTX-S	
83	2	1988-32-32	
84	2	5151HK-32	
85	4	HC-200	
<u>DRILL OPERATOR GAUGE, HOSE, AND FITTING IF ORDERED</u>			
112	1	0-6000PSI BOTTOM MTG GAUGE	
113	1	4-4 GTX-S	
114	1	F471TC0606-4-4-4-660	
115	1	4-4-4-S50X-S	

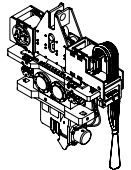

VII. MODEL 475 POWER UNIT (Continued...)

VII-2. Electrical Controls

ELECTRICAL CONTROL & GAUGES



PENDANT CONTROL

HYDRAULIC SYSTEM GAUGES

MAIN CONTROL PANEL



OPERATION / MAINTENANCE MANUAL

MODEL 475 POWER UNIT

7032 SOUTH 196th - KENT, WA. 98032 - (253) 872-0141 / FAX (253) 872-8710

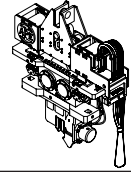

VII. MODEL 475 POWER UNIT (Continued...)

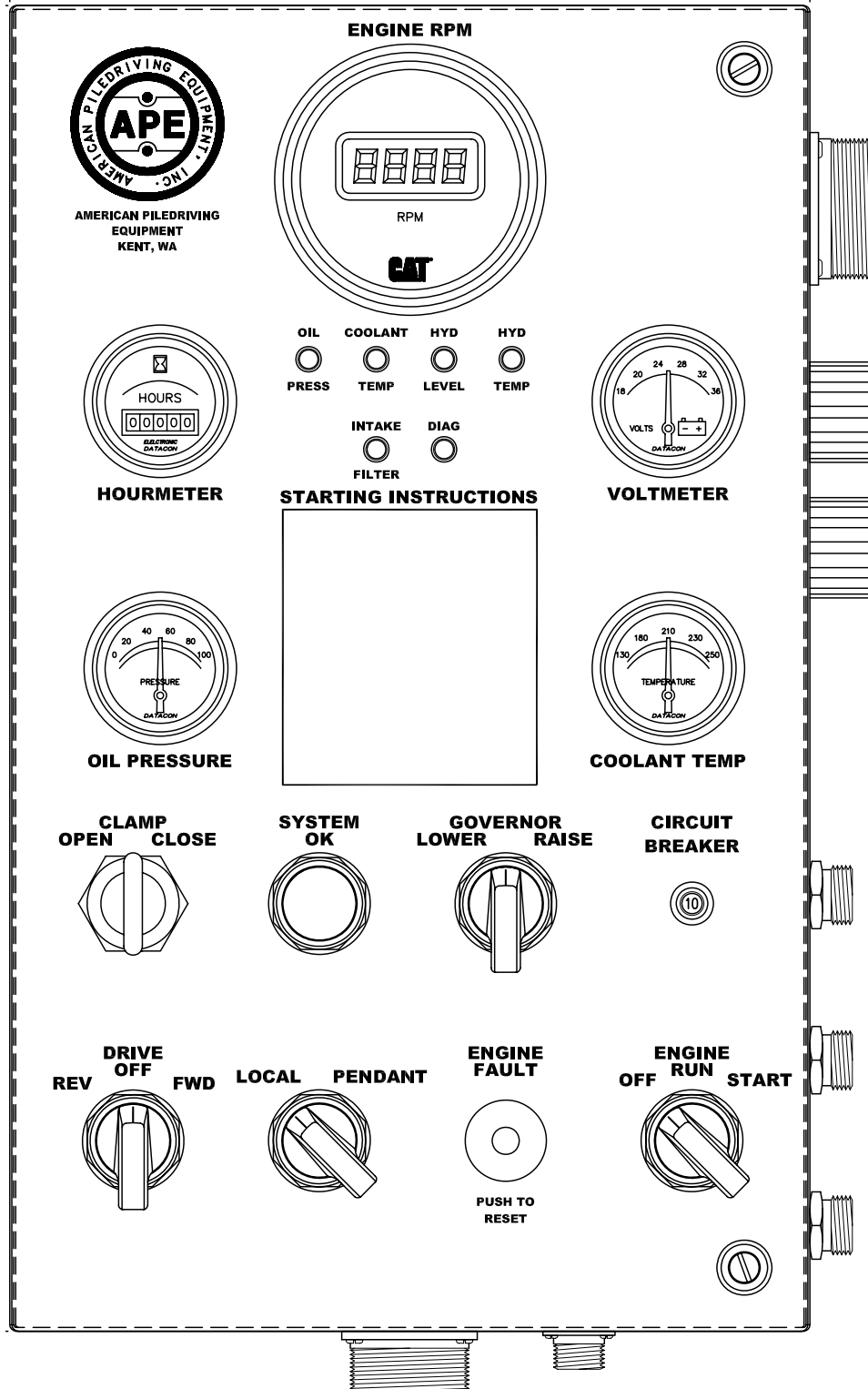



OPERATION / MAINTENANCE MANUAL

MODEL 475 POWER UNIT

7032 SOUTH 196th - KENT, WA. 98032 - (253) 872-0141 / FAX (253) 872-8710

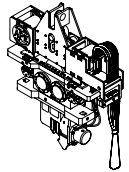

VII. MODEL 475 POWER UNIT (Continued...)

VII-2. Electrical Controls: (Understanding How They Work)

The Main Control Panel (located behind one of the doors on the left side of the Power Unit) contains all of the equipment necessary to Start, Control, and Monitor the Engine, as well as control the Vibro functions. Remote control of the Vibro functions can be achieved by plugging either a Remote Pendant Switch, or a Radio Receiver into the 12 pin receptacle, located on the bottom of the panel. The Pendant Switch will allow the operator to move about in approx. a 50 ft radius of the Power Unit. The Radio will allow the operator to move about in approx. a 400 ft radius of the Power Unit.

VII-2A. Main Circuit Breaker

A circuit breaker is provided to protect the control wiring in the event of an electrical overload or a shorted circuit. If the circuit breaker should trip, find and repair the fault, then reset the breaker by pressing the circuit breaker reset button on the face of the Control Panel.

VII-2B. Tachometer

A digital tachometer, located on the front of the control panel, is provided to monitor the engine RPM. A magnetic sensor picks up a signal from the flywheel, and sends it to the tachometer. If there is reason to doubt the accuracy of the tachometer, check the engine RPM with a phototach, then calibrate the tachometer gage. The factory should be consulted for proper setting of the tach switches.

VII-2C. Hourmeters

Two hourmeters are on the Control Panel, one on the face of the panel, and one inside the panel. The hourmeter on the face of the panel monitors the time that the engine is running. The hourmeter inside the panel monitors the time that the "Forward Drive" is operating.

VII-2D. Engine Safety Shutdown Switch (Murphy Magnetic Switch)

Mounted to the back side of the Control Panel Door, is a Murphy Magnetic switch with a manual reset button protruding through the front of the Panel Door. When the contact on the switch is closed, power is supplied to the fuel valve solenoid, the hourmeter, and the "System OK" light. When the contact is open, the above items will be de-energized, and the engine will not run. The contact can be manually closed by pressing the "Reset" button on the face of the control panel. The contact will remain latched closed, unless the coil on the switch is energized. Each time the coil is energized, the contact will be unlatched, and the contact will open, to stop the engine. There are five switches that can energize the coil on the Murphy magnetic Switch, to stop the engine, (Engine Oil Pressure Gage, Engine Coolant Temperature Gage, Hydraulic Oil Temperature Gage, Hydraulic Oil Level Switch, and Emergency Stop Button on either the Pendant Switch, or the Radio).

VII-2E. Murphy "Engine Oil Press" gage

The Engine Oil Pressure Gage is located on the door of the Main Control Panel. A low cutoff switch is located inside the Murphy "Engine Oil Press" gage. When the engine oil pressure is too low, the switch will close to energize the coil in the Murphy Mag Switch. The cutoff pressure has been set at the factory. If the setting should need to be changed, use the adjustment screw provided in the front of the gage. A 1/16" allen wrench is required. Each time the engine is to be started, the Murphy Mag Switch coil will be energized by the switch in this gage. To start the engine, one must press and hold the manual reset button on the Murphy Mag Switch until sufficient engine oil pressure is achieved. Sufficient oil pressure has been achieved when the "Oil Press" light on the face of the Control Panel goes out.)



OPERATION / MAINTENANCE MANUAL

MODEL 475 POWER UNIT

7032 SOUTH 196th - KENT, WA. 98032 - (253) 872-0141 / FAX (253) 872-8710

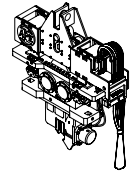

VII. MODEL 475 POWER UNIT (Continued...)

VII-2F. Murphy “Engine Coolant Temp” gage

The Engine Coolant Temperature Gage is located on the door of the Main Control Panel. A high cutoff switch is located in the Murphy “Engine Coolant Temp” gage. When the engine temperature is too high, the switch will close to energize the coil in the Murphy Mag Switch. The cutoff pressure has been set at the factory. If the setting should need to be changed, use the adjustment screw provided in the front of the gage. A 1/16” allen wrench is required. (Do not set the cutoff temperature above 220 deg F. without factory permission)

VII-2G. Murphy “Hyd Oil Temp” gage

The Hydraulic Oil Temperature Gage is located in the Gage Assembly on the left of the Control Panel. A high cutoff switch is located in the Murphy “Hyd Oil Temp” gage. When the hydraulic oil temperature is too high, the switch will close to energize the coil in the Murphy Mag Switch. The cutoff pressure has been set at the factory. If the setting should need to be changed, use the adjustment screw provided in the front of the gage. A 1/16” allen wrench is required.

VII-2H. Hydraulic Oil Level Float Switch

The “Hyd Oil Level” float switch is located in the hydraulic oil reservoir, next to the sight gage. A glass window is provided in the switch so that the float and oil level can be observed. If the oil level gets too low, the switch will close to energize the coil in the Murphy Mag Switch.

VII-2I. Pendant “Emergency Stop” button

To stop the engine in an emergency, press the “Emergency Stop” button on the hand held Pendant Switch. This “Emergency Stop” switch will work, regardless of the position of the “Local-Pendant” selector Switch.

VII-2J. Radio “Emergency Stop” Button

To stop the engine in an emergency, press the red “Emergency Stop” button located near the antenna on the radio transmitter. This switch will work, regardless of the position of the “Local-Pendant” selector switch. NOTE: In order for the radio “Emergency Stop” button to work, both the Radio Receiver and the Radio Transmitter have to have been on, and operational.

VII-2K. Pilot lights

There are five pilot lights on the face of the control panel that are associated with the Safety Shutdown Switch discussed above.

1. “System OK” light. A lit “System OK” light is an indication that the Engine Oil Pressure, Engine Coolant Temperature, Hydraulic Oil Temperature, and the Hydraulic Oil Level are all okay. When the “System OK” light is not lit, the engine will have been automatically stopped. The problem can be detected by observing the following lights.
2. “Engine Oil Press” light. Any time the engine oil pressure is too low, this light will be on, (with the following exception). If the “Engine Coolant Temperature Gage”, the Hydraulic Oil Temperature Gage, or the Hydraulic Oil Level Switch has stopped the engine, the “Engine Oil Press” light will not be on; but, one of the following lights will be on.
3. “Engine Coolant Temp” light. If the Engine Coolant Temp is too high, this light will be on.
4. “Hydraulic Oil Temp” light. If the Hydraulic Oil Temperature is too high, this light will be on.
5. “Hydraulic Oil Level” light. Any time the Hydraulic Oil Level is too low, this light will be on.

In addition to the above, there is a pilot light in each of the terminal connectors on the solenoid valves. By observing these lights, one can tell which solenoids are energized.



OPERATION / MAINTENANCE MANUAL

MODEL 475 POWER UNIT

7032 SOUTH 196th - KENT, WA. 98032 - (253) 872-0141 / FAX (253) 872-8710

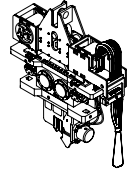

VII. MODEL 475 POWER UNIT (Continued...)

VII-2L. Engine Control Switch “OFF-ON-START”

The Engine Control Switch is located on the front of the control panel, and is used to start and stop the diesel engine, as well as control power to all other electrical equipment on the power unit. This switch must be in the “on” position before the engine or any of the other electrical components will operate. The “off” and “on” positions are detented, but the “start” position is spring loaded to the “on” position. Turning the switch to the “start” position will energize the starter motor on the engine.

VII-2M. “LOCAL— PENDANT” Switch

This switch is also located on the main control panel, and determines the location from which the vibro can be operated. The vibro can not be operated from more than one location at a time. When this switch is turned to the “local” position, the vibro can be operated only by the switches on the power unit control panel. In the “pendant” position, operation of the vibro is controlled by either the Hand Held Pendant Switch, or the Radio (depending on which one is plugged into the bottom of the Control Panel).

CAUTION should be used when changing the position of this switch. Check to make sure that all of the Drive “Forward/Reverse” switches, and “Clamp” switches (including the Radio) are turned “off” before turning this switch. If any one of the above switches are “on”, the vibro eccentrics or clamp could be accidentally activated, causing mechanical damage or personal injury.

If neither the Hand Held Pendant nor the Radio is plugged into the Receptacle on the bottom of the Control Panel, this switch must be in the “local” position before the engine can be started.

VII-2N. Governor Control Switches “RAISE-off-LOWER”

Governor Control switches can be found on the Main Control Panel, the Held Pendant, and/or the Radio Transmitter. The “Local-Pendant” switch determines which one is operable. To increase the engine rpm, turn the appropriate governor control switch to the “Raise” position. To decrease the engine rpm, turn the switch to the “Lower” position. On power units equipped with Caterpillar engines, the switches are connected directly to the engine governor. On power units equipped with Cummins engines, the switches control a Murphy Actuator, which in turn, operates a control arm on the engine governor. On both the Caterpillar and Cummins models, there is a manual throttle control, which can override the electric control. The electric control cannot lower the engine rpm below that set by the manual throttle control.

VII-2O. Clamp Control Switches (“OPEN-off-CLOSE”)

A Clamp Control Switch can be found on the Main Control Panel, the Hand Held Pendant, and/or the Radio Transmitter. The “Local-Pendant” switch determines which one is operable.

The Clamp Control Switches on the Control Panel and the Hand Held Pendant are detented in the “off” and “close” positions. The “open” position is spring loaded back to the “off” position.

When the ‘active’ Clamp Control Switch is in the “off” position, oil from the Clamp Pump is routed through the Clamp Solenoid Valve back to tank.



OPERATION / MAINTENANCE MANUAL

MODEL 475 POWER UNIT

7032 SOUTH 196th - KENT, WA. 98032 - (253) 872-0141 / FAX (253) 872-8710

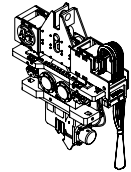

VII. MODEL 475 POWER UNIT (Continued...)

VII-20. Clamp Control Switches (“OPEN-off-CLOSE”) (Continued...)

When the ‘active’ Clamp Control Switch is turned to the “open” position, The “open” solenoid on the Clamp Valve is energized, causing oil to be directed to the rod end of the Clamp Cylinder, provided the drive “Forward/Reverse” Switch is in the “off” position. (The clamp “open” solenoid cannot be energized when the “Drive Forward” switch is activated.) If the Clamp Control Switch is held in the “open” position after the clamp is fully open, oil pressure will build in the system until oil is flowing over a pressure relief valve, creating heat.

When the ‘active’ Clamp Control Switch is turned to the detented “Close” position, the “close” solenoid on the Clamp valve is energized, causing oil to be directed to the blind end of the Clamp Cylinder. Once the Clamp is closed, and sufficient oil pressure (4000psi) has built in the system, a pressure switch will open the circuit to the solenoid valve, and energize a pilot light located in the Clamp Control Switch Operator. A lit pilot light in the Clamp Control Switch Operator is an indication that there is enough oil pressure in the clamp circuit to safely run the vibro eccentrics.

If oil pressure in the Clamp circuit should bleed off to a predetermined level(3300psi), the pressure switch will de-energize the pilot light, and re-energize the “close” solenoid on the Clamp valve until pressure in the clamp circuit reaches 4000psi again. This cycle will continue until the Clamp switch is turned to the “off” position.

Operation of the Clamp “open/close” switch on the radio transmitter is similar, but slightly different, in that the switch on the Radio Transmitter is not detented in the “close” position.

The first time the Clamp switch on the transmitter is moved to the “close” position, the radio output signal to the “close” solenoid on the Clamp valve will be latched on. The oil pressure switch will function the same as above, but the operator will have to look on the control panel or the hand held pendant switch to observe the pilot light.

The next time the Clamp switch on the transmitter is moved to the “close” position, the radio output signal to the “close” solenoid on the Clamp valve will be turned “off”. Each time the switch is moved to the “close” position, the radio output will be alternately turned “on”, or “off”. The radio’s Clamp “close” output signal can also be turned “off” by moving the switch to the “open” position.

As long as the Clamp switch on the radio transmitter is held in the “open” position, the radio will send an output signal to the “open” solenoid on the Clamp valve, provided both the “Drive Forward” and “Drive Reverse” outputs are turned off. (The clamp “open” solenoid cannot be energized when the “Drive Forward” output is activated.) If the Clamp Control Switch is held in the “open” position after the clamp is fully open, oil pressure will build in the system until oil is flowing over a pressure relief valve, creating heat.



OPERATION / MAINTENANCE MANUAL

MODEL 475 POWER UNIT

7032 SOUTH 196th - KENT, WA. 98032 - (253) 872-0141 / FAX (253) 872-8710

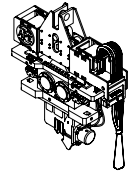

VII. MODEL 475 POWER UNIT (Continued...)

VII-2P. Drive Control Switches (“FORWARD/off/REVERSE”)

Drive Control Switches can be found on the Main Control Panel, the Hand Held Pendant, and/or the Radio Transmitter. The “Local-Pendant” Selector Switch determines which one is operable.

The Drive Control Switches on the Control Panel and the Hand Held Pendant are detented in all three positions. They must be in the “off” position, before the engine can be started.

When operating a Drill, both the “Forward” and “Reverse” positions can be used. The “Forward” position would be used to drive the drill forward. The “Reverse” position would be used to drive the drill backwards.

When operating the eccentrics on a vibro, only the “Forward” drive should be used. If the “Reverse” drive is used, the majority of the oil will pass through the anti-cavitation valves located in the vibro suppresser housing, and the vibro eccentrics will not run properly.

The operation of the switches on the Radio Transmitter are similar to the Control Panel and Pendant operation, with the following exception. There are two switches on the transmitter, one for “Forward”, and one for “Reverse”. Neither is detented. When the “Drive Forward” switch on the transmitter is moved to the “on” position, the “Drive Forward” output signal from the radio is latched “on”. To turn the “Drive Forward” output signal “off”, move the “Drive Forward” switch on the transmitter to the “off” position. The “Reverse” output works the same way.

It is possible to plug reverse the drive motor by alternately moving the “Forward” and “Reverse” switches on the transmitter to the “on” position, without using the “off” positions. This is hard on the equipment, and should be avoided. If a drive is turned “on”, it should always be turned “off”, and the equipment allowed to stop, before the opposite drive is turned “on”.

VII-2Q. Preparing the Electrical System for Engine Startup.

The following procedure should be followed at Engine Startup:

1. The Circuit Breaker must be closed (Pushed in and locked).
2. Turn the Clamp Switches on both the Control Panel and the Pendant to the ‘Off’ position.
3. Turn the Drive Switch on both the control panel and the Pendant to the ‘Off’ position.
4. If neither a Hand Held Pendant, nor a Radio is plugged into the receptacle on the bottom of the Control Panel, this switch must be in the ‘Local’ position.
5. Check to make sure that both the Manual Throttle Control, and the Governor Control is properly set.
6. Turn the Engine Control Switch to the ‘On’ position.
7. Check the Pilot Lights on the face of the Control Panel. If any of the lights, other than the “Engine Oil Pressure” light is on, correct the problem before proceeding. If the ‘Engine Oil Pressure’ light is on, proceed to step #8.
8. Depress and hold the button on the Engine Safety Shutdown Switch (Murphy Switch). This button must be depressed until Engine Oil Pressure is present.
9. Turn the Engine Control Switch to the ‘Start’ Position to engage the Starter Motor.
10. Once Engine Oil Pressure is present, release the Emergency Shutdown Switch.



OPERATION / MAINTENANCE MANUAL

MODEL 475 POWER UNIT

7032 SOUTH 196th - KENT, WA. 98032 - (253) 872-0141 / FAX (253) 872-8710

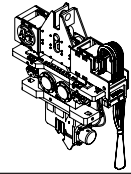

VII. MODEL 475 POWER UNIT (Continued...)

This page intentionally left blank.

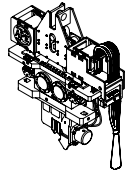

VII. MODEL 475 POWER UNIT (Continued...)

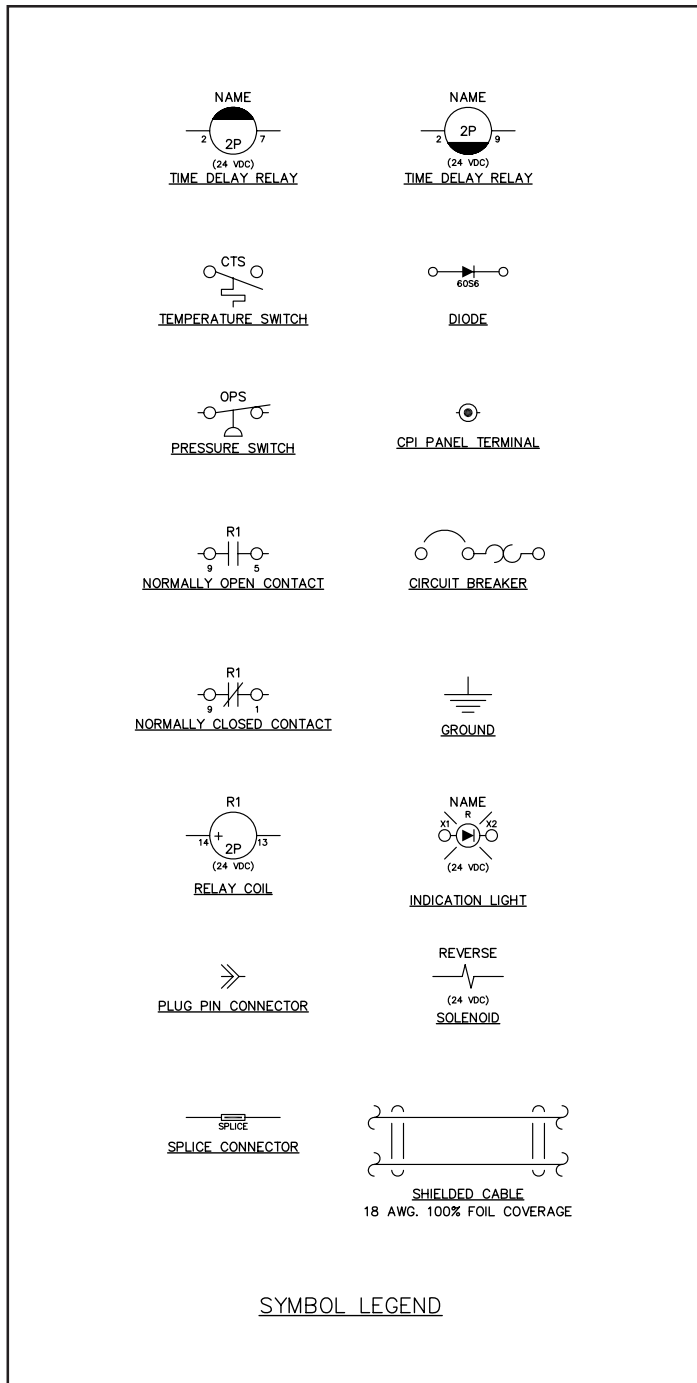

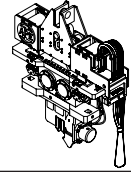

VII. MODEL 475 POWER UNIT (Continued...)

VII-2R. Electrical Schematic with Pendant Control

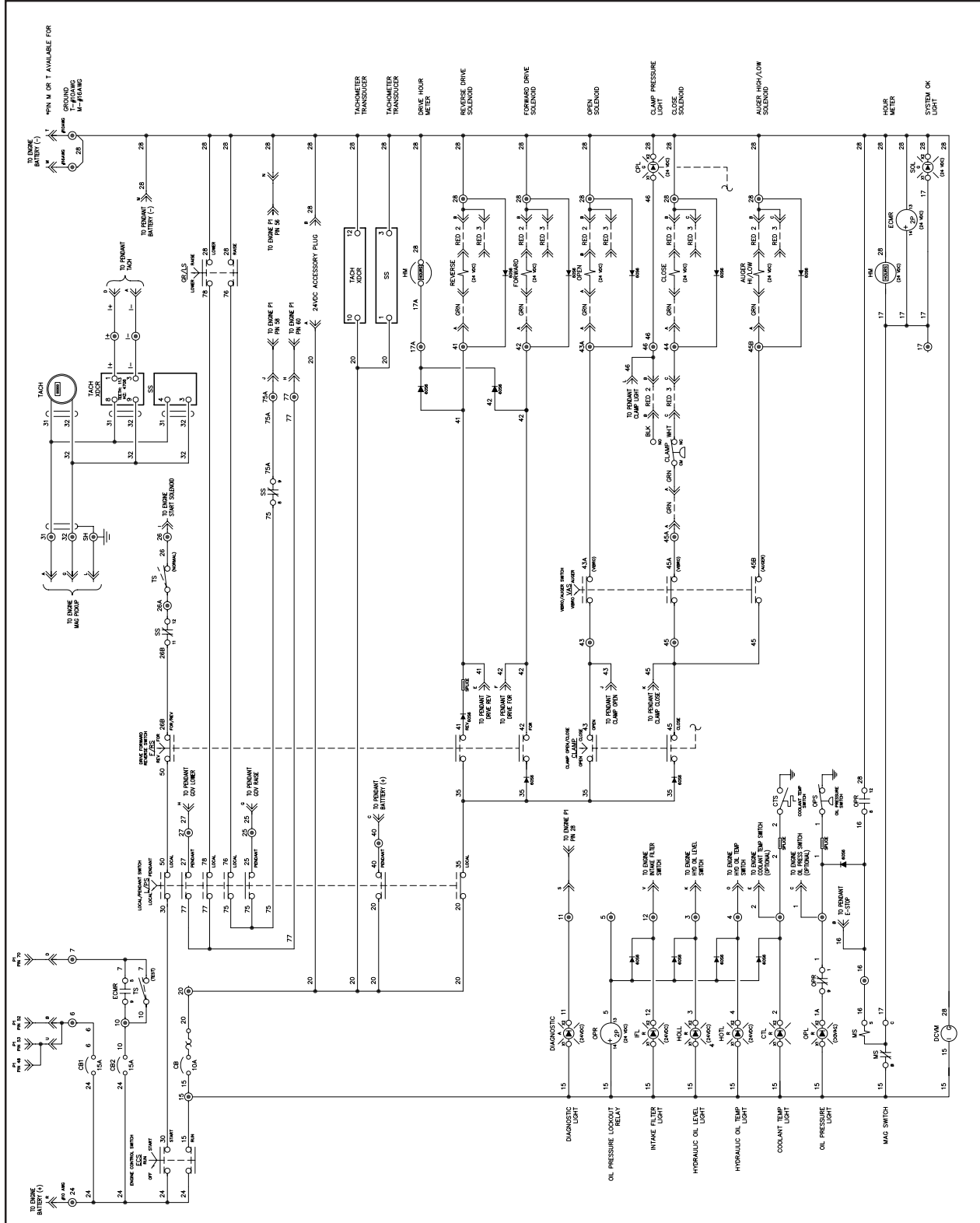

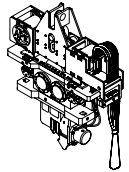

VII. MODEL 475 POWER UNIT (Continued...)

VII-3. Remote Control Pendant

A "REMOTE HAND HELD CONTROL PENDANT" is provided to allow operation of the power unit at a distance of up to 50 feet (15 meters) and can be extended using 50 foot extension cables. The "REMOTE HAND HELD CONTROL PENDANT" is connected to the control panel via a multiconnector plug.

The Pendant Switch is particularly handy as a trouble shooting tool, in that the operator can position himself near the Control Valves while checking them. To make the Pendant Switches operable, turn the 'Local-Pendant' Switch to the 'Pendant' position, and the Engine Control Switch to the 'On' Position. (The Engine does not need to be running.) Each time a solenoid is energized, a pilot light on the connector to that solenoid should light up.

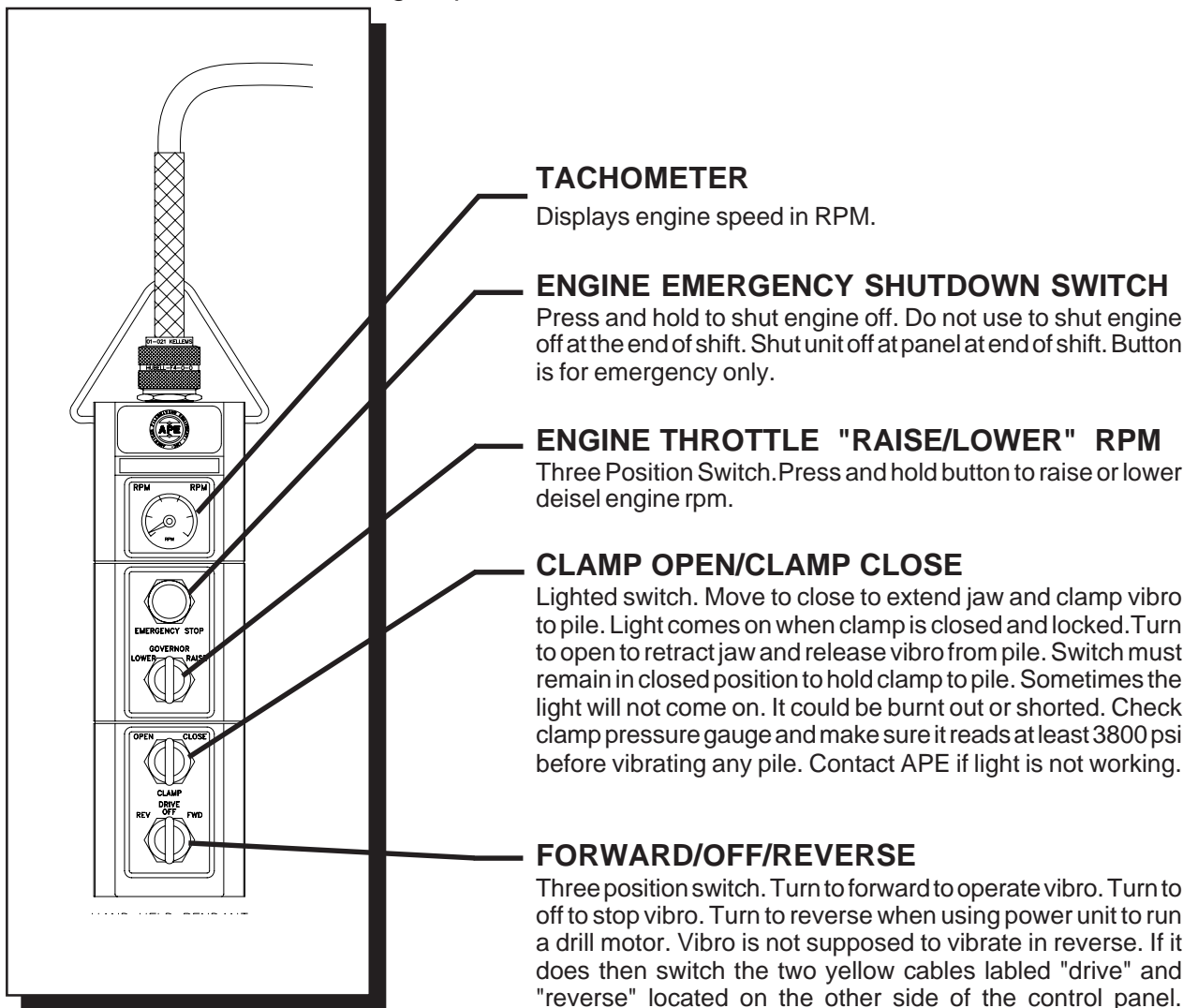
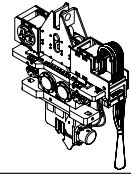

Figure 7-L. Remote Control Pendant

WARNING: Never leave vibro clamped to a pile without the crane line attached. The clamp cylinder could bleed off causing the vibro to drop. Never hoist a pile in the air without a safety line attached to the pile. Should the clamp close line become damaged and leak, the clamp cylinder could lose pressure and drop the pile.



VII. MODEL 475 POWER UNIT (Continued...)

VII-3A. Remote Pendant Wiring Diagram

The following is the pin wiring configuration and the wire colors of the amphenol connectors for the remote control pendant cable.

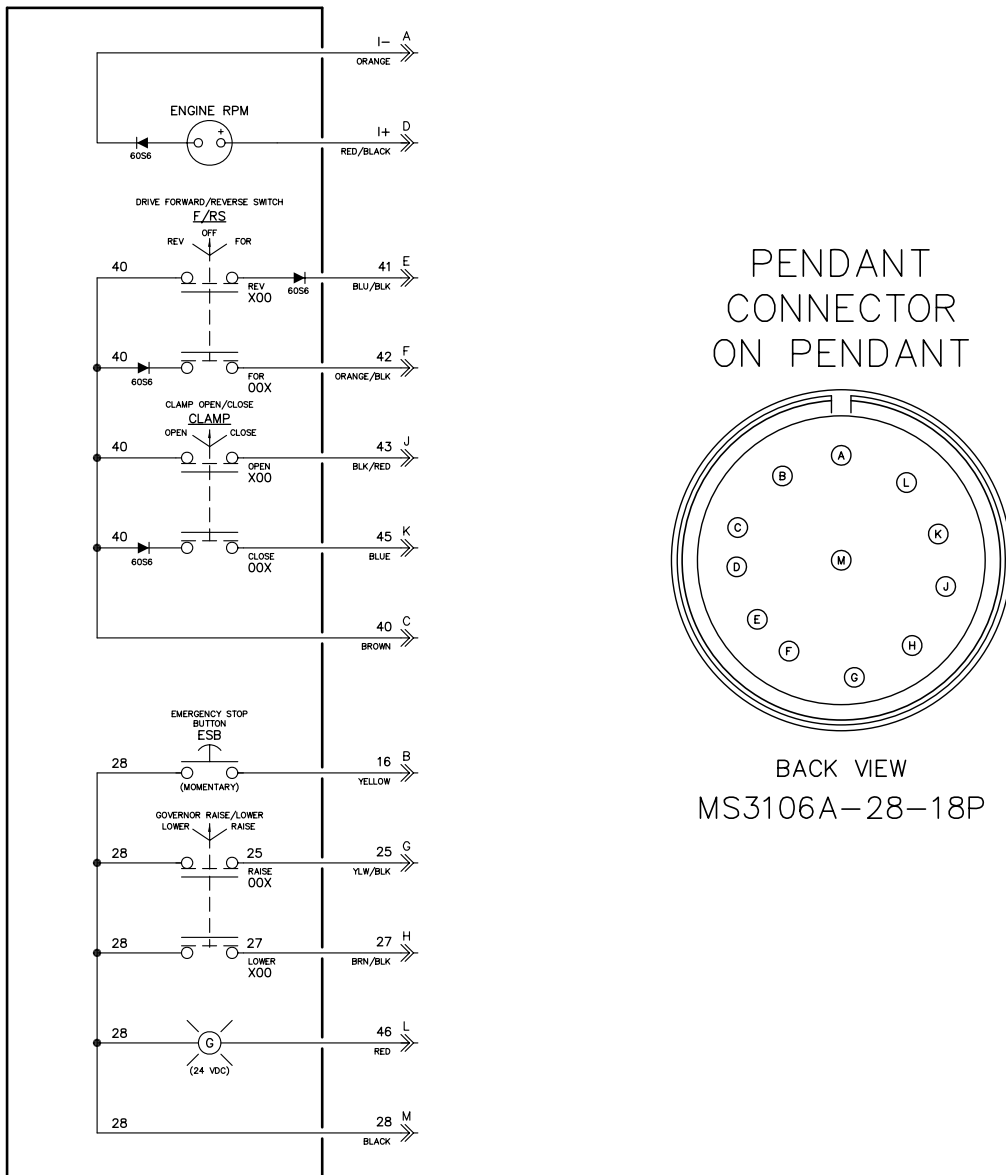
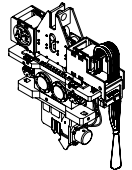
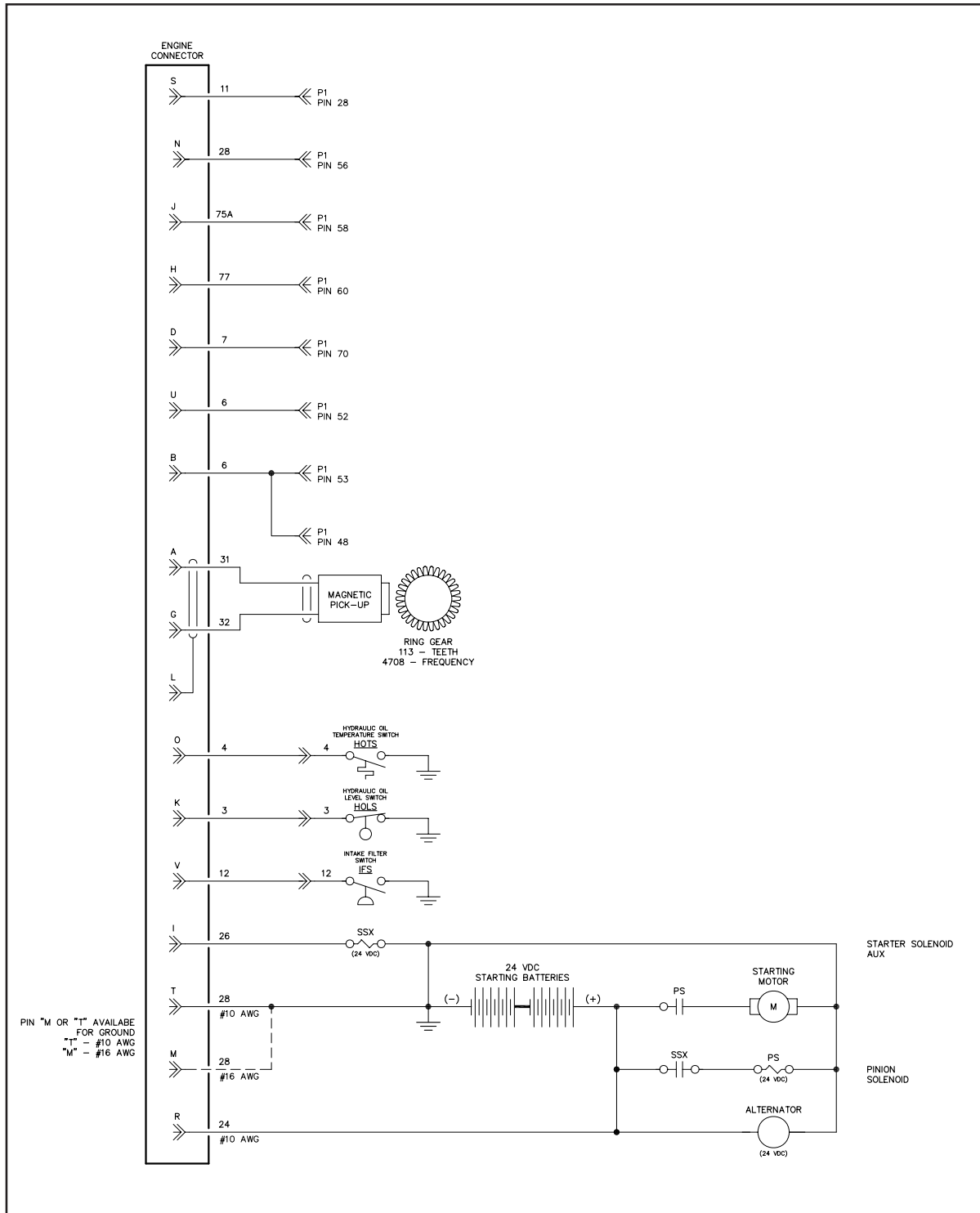

Figure 7-M. Remote Pendant Wiring Diagram



VII. MODEL 475 POWER UNIT (Continued...)



Engine Connector Wiring



OPERATION / MAINTENANCE MANUAL

MODEL 475 POWER UNIT

7032 SOUTH 196th - KENT, WA. 98032 - (253) 872-0141 / FAX (253) 872-8710

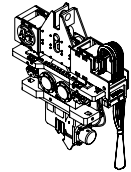

- APPENDIX A - **CAT C13 ENGINE**

A-1. ENGINE OPERATION INSTRUCTIONS

The following sections are basic instructions for maintenance and operation of the **APE Model 475 Power Unit Engines**. All maintenance should be performed by qualified personnel who are familiar with the equipment. (Consult the factory for additional information.)

A-1A. PRE-START INSPECTION AND PROCEDURES

1. Make a "walk-around" inspection of the engine and components for the oil, water or fuel leaks and general appearance. Correct minor adjustments before they develop into major repair jobs.

2. Check the crankcase oil level. Maintain the oil level between the ADD and FULL marks on the dipstick. See OIL SPECIFICATIONS for type of oil to use.

3. Check oil level(s) on driven equipment.

WARNING: Check the engine coolant level when the engine is cool. If the engine is warm, steam may spray outward under high pressure and cause personal injury.

4. Check the engine jacket coolant level. Slowly turn the pressure cap until the cap is removed. Maintain coolant level to the base of the fill pipe.

5. Check the fuel supply. Keep fuel tanks full, as partially filled tanks will collect moisture. See the FUEL SPECIFICATIONS for type of fuel.

KEEP THE FUEL SUPPLY CLEAN

6. Open the raw water valve on the engine jacket heat exchanger system (if so equipped). Prime the raw water pump if the raw water system has been drained.

7. Reset shutoff devices. See the topic, ATTACHMENTS, Emergency Shutoff Devices and Alarms. If the engine is equipped with an air safety shutoff control, and was tripped to the shutoff position, reset the latch to the run position.

8. Open the fuel supply valve. If the engine has not run for some time it may be necessary to prime the system. See the topic, PRIMING THE FUEL SYSTEM.

9. Disconnect any battery charger which is not protected against starting motor drain.

10. Disengage the clutch, or open the circuit breaker on a generator set.



OPERATION / MAINTENANCE MANUAL

MODEL 475 POWER UNIT

7032 SOUTH 196th - KENT, WA. 98032 - (253) 872-0141 / FAX (253) 872-8710

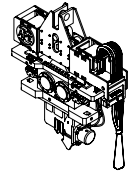

- APPENDIX A - **CAT C13 ENGINE**

A-1B. STARTING THE ENGINE.

CAUTION: Do not engage the starter when the flywheel is moving.

Electric Starting

1. Move the governor control lever to approximate half engine speed position.
2. Use starting aids if required.
3. Push the START button; or turn the HEAT START switch to the START position, depending upon the control the engine has. Release the control as soon as the engine starts.

For generator sets, place the AUTO-MAN switch in the MAN position to crank the engine. As soon as the engine starts, and the engine speed reaches 600 rpm and oil pressure is approximately 22 psi (1.5 kg /CM²), the starter motor will disconnect from the circuit. (The STOP position is used to stop the diesel engine.)

If the engine fails to start within 10 seconds, move the governor control lever to the fuel off position, then continue to crank for 10 seconds. This will clear the cylinders of unburned fuel.

If the engine fails to start after 30 seconds of cranking, allow the engine to cool for 2 minutes before repeating the starting procedure.

CAUTION: Prolonged cranking at low oil pressure can activate the mechanical safety shut-off. If the reset lever is in the shut-off position, reset the mechanical shut-off control.

CAUTION: NEVER use starting aids when the engine is warm and running.

Air Starting

1. Open and close the bleed valve on the bottom of the air tank to drain condensation and oil carryover.
2. Check the air supply pressure. The air start must have 100 PSI (7 kg/cm²) to operate properly.
3. Keep oil level, in the oiler jar, at least half full. Add oil if necessary.
4. Push the air valve control in to crank the engine. As soon as the engine starts, release the valve.



OPERATION / MAINTENANCE MANUAL

MODEL 475 POWER UNIT

7032 SOUTH 196th - KENT, WA. 98032 - (253) 872-0141 / FAX (253) 872-8710

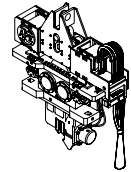

- APPENDIX A - CAT C13 ENGINE

A-1. OPERATION INSTRUCTIONS. (Continued...)

A-1C. ENGINE OPERATION.

After the engine starts, and at frequent intervals while the engine is operating, the gauges should be observed. Determine the normal reading for each gauge. Investigate the cause whenever there is a significant change in the reading.

Tachometer

The tachometer indicates engine RPM. The high idle RPM and the full load RPM are stamped on the engine's information plate. The engine can be operated between these two speed limits for long periods of time without shortening engine life. Prolonged operation at high idle with little or no load can cause adverse engine operation.

Engine Oil Pressure

If the gauge reading fluctuates after the load is stable:

1. Remove the load.
2. Reduce engine speed to low idle.
3. Observe the oil level. Maintain the oil level between the ADD and FULL mark on the dipstick. If the reading continues to fluctuate when the oil level is correct, stop engine and call your Caterpillar dealer.

Engine Jacket Water Temperature

The engine should operate within the NORMAL (green) range. If the engine is operating in the (red) range and steam becomes apparent:

1. Reduce the load and engine RPM.
2. Inspect for coolant leaks.
3. Determine if the engine must be shut down immediately; or if the engine can be safely cooled by reducing the load. (See COOLING SPECIFICATION INSTRUCTIONS.)

CAUTION: Do not add cold water to a hot engine: Cracking of engine components may occur. Allow the engine to cool, then add coolant.



OPERATION / MAINTENANCE MANUAL

MODEL 475 POWER UNIT

7032 SOUTH 196th - KENT, WA. 98032 - (253) 872-0141 / FAX (253) 872-8710

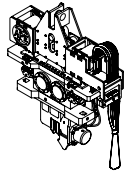

- APPENDIX A - **CAT C13 ENGINE**

A-1C. ENGINE OPERATION (Continued...)

-Water Temperature Gauge

If the temperature gauge reading registers in or near the cold range (white) while operating under load:

1. Check the water temperature gauge for accuracy.
2. Check the temperature regulators for proper temperature range. Replace regulators if necessary.

Fuel pressure

If the fuel filter gauge registers in the OUT range, clean the primary fuel filter, if so equipped. Install new secondary or final fuel filter elements if gauge still registers OUT. See the FUEL MAINTENANCE INSTRUCTIONS and FUEL SPECIFICATIONS.

Ammeter:

The ammeter reading is normal when the indicator is at or on the (+) side of zero, when the engine is running at rated speed. If indicator is to the left (-) side of zero, investigate and correct cause.

Air Cleaner Service Indicator

When the gauge indicator locks in the red range, service the air cleaner. With the engine stopped.

Calibrated Gauges

Calibrated gauges are used on some engines to monitor the engine systems. If an abnormal engine condition develops, determine and analyze and correct the cause before a failure and downtime occurs.

If any of the gauges register at or outside the operating limits, investigate and correct any malfunction. See TROUBLESHOOTING for guidance.

**WARNING: Shut the engine down if work on or around the engine is required.
DO NOT OPERATE THE ENGINE WITH THE GAUGES REGISTERING AT OR OUTSIDE
THE LIMITS.**



OPERATION / MAINTENANCE MANUAL

MODEL 475 POWER UNIT

7032 SOUTH 196th - KENT, WA. 98032 - (253) 872-0141 / FAX (253) 872-8710

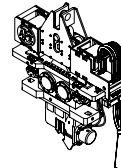

- APPENDIX A - **CAT C13 ENGINE**

A-1C. ENGINE OPERATION (Continued...)

Altitude Operation

The fuel system settings and altitude limits are stamped on the engine information plate. When an engine is moved to a higher altitude, these settings must be changed by your Caterpillar dealer in order to prevent damaging the turbocharger, and to provide maximum engine efficiency. If the engine is moved to a lower altitude than that which is stamped on the engine information plate, the engine can be operated safely; however, it will deliver less than rated horsepower, and the fuel settings should be changed by your Caterpillar dealer to obtain rated horsepower.

Stopping

1. Flywheel clutch operation: Quickly pull the clutch lever to the released position.
2. Reduce engine speed to half speed. Run for 5-10 minutes to cool engine.
3. Reduce engine speed to low idle.
4. Observe the crankcase oil level while the engine is idling. Maintain the oil level between the ADD and FULL marks on the side of the dipstick stamped, CHECK WITH ENGINE RUNNING. See the LUBRICATION AND MAINTENANCE SECTION.
5. Stop the engine.

After Stopping Checks And Procedures

1. Fill the fuel tank. See the LUBRICATION AND MAINTENANCE SECTION: Fuel Tank Maintenance.
2. Drain the raw water system if below freezing temperatures are expected; see: Draining Raw Water System.
3. If below freezing temperatures are expected, allow the engine jacket water expansion tank to cool, then check the coolant for proper antifreeze protection. Add permanent-type antifreeze, if required.
4. Repair any leaks, make major adjustments, tighten loose bolts, etc.
5. Observe the Service Meter reading. Perform the periodic maintenance as instructed in the LUBRICATION AND MAINTENANCE CHART.



OPERATION / MAINTENANCE MANUAL

MODEL 475 POWER UNIT

7032 SOUTH 196th - KENT, WA. 98032 - (253) 872-0141 / FAX (253) 872-8710

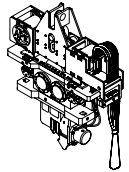

- APPENDIX A - **CAT C13 ENGINE**

A-1C. ENGINE OPERATION (Continued...)

Starting The Engine

1. Perform all prestart checks outlined previously.
2. Place the CONTROL switch in the MANUAL position to crank the engine.
3. When the engine starts and engine rpm reaches 600 rpm and the oil pressure registers 22 psi (1.5 kg/cm²) the starting motor will automatically disconnect from the start circuit.
4. Start the load.
5. Regulate the engine speed with the RAISE LOWER switch to the required instrument panel gauge readings.

Stopping The Engine

1. Remove the load.
2. Reduce engine speed to low idle: Push down and hold the RAISE-LOWER switch until the engine low idle speed is reached.
3. While the engine is idling, check the engine oil level. Oil level must be maintained between the ADD and FULL marks on the side of the dipstick marked "CHECK WITH ENGINE RUNNING".
4. Stop the engine.

(Solenoid Shutoff)

- a. Move the control switch to the STOP or OFF positions. (Do not confuse this with the "RAISE-LOWER" switch.)

(PSG Governor:)

- b. Move the shutoff lever forward, or hold the lever up, depending upon installation. Hold the lever in this position until the engine stops.

5. Fill the fuel tank. See the LUBRICATION AND MAINTENANCE section.
6. Drain the raw water system if below freezing temperatures are expected.

Observe the Service Meter reading. Perform the periodic maintenance as instructed in the LUBRICATION AND MAINTENANCE CHART.



OPERATION / MAINTENANCE MANUAL

MODEL 475 POWER UNIT

7032 SOUTH 196th - KENT, WA. 98032 - (253) 872-0141 / FAX (253) 872-8710

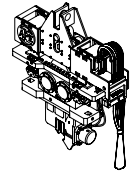

- APPENDIX A - CAT C13 ENGINE

A-1D. Determining Cause Of Shutdown

CAUTION: If the engine has been shutdown by a safety device, don't start the engine and place it into service without having the cause of the shutdown investigated and corrected

Low Oil Pressure Checks

If the low oil pressure shutoff control has stopped the engine, make the following checks:

1. Check the water temperature gauge. Determine if the engine was overheated. Check for external water leaks.

WARNING: Beware of steam or scalding water. Do not attempt to loosen the radiator cap until the temperature gauge indicates the coolant has sufficiently cooled. Then, loosen the cap slowly.

2. Check the oil level. Oil level must be between the ADD and FULL marks on the side of the dipstick stamped CHECK WITH ENGINE STOPPED.
3. If the oil level is below the ADD mark, check for oil spray and/or oil accumulations. If any are found, have the necessary repairs made. Before starting, add oil to the FULL mark.
4. Reset the shutoff control.
5. Remove the load and start the engine at its slowest speed. Be prepared to shut the engine down manually.
6. Be alert for unusual sounds or noises. If the engine knocks, stop the engine immediately and call your engine dealer.
7. If the engine blows excessive black exhaust or has excessive crankcase blow-by, the engine may need reconditioning. Stop the engine and call your engine dealer.
8. If the engine runs satisfactorily, observe the oil pressure gauge. If satisfactory pressure is not indicated, shut the engine down; call your engine dealer.
9. If proper oil pressure is registered, check to see if the reset knob has moved to the run position. If the knob does not move, stop the engine. Check the shutoff control, the oil line, and the oil pressure gauge. Have necessary repairs made.
10. If the oil pressure gauge registers normal oil pressure, if the knob on the shutoff control moves to the run position, and if the engine operation is otherwise satisfactory, determine if the high water temperature shutoff may have shut down the engine.



OPERATION / MAINTENANCE MANUAL

MODEL 475 POWER UNIT

7032 SOUTH 196th - KENT, WA. 98032 - (253) 872-0141 / FAX (253) 872-8710

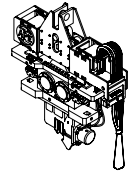

- APPENDIX A - **CAT C13 ENGINE**

A-1D. Determining Cause Of Shutdown (Continued...)

High Water Temperature Checks-Engine Running

1. Determine if the load was too great for the engine - Reduce the load and allow the engine to cool while running.
2. If pressure steam or water leaks are visible, remove the load and stop the engine. Have necessary repairs made.
3. Check for collapsing or deteriorated water hoses. Have repairs made.
4. Check for noisy water pump operation. Have necessary repairs made.
5. Refill the cooling system with a solution of water and permanent-type antifreeze if below freezing temperatures are expected; or with a solution of approved water and Corrosion Inhibitor. Follow the instructions on the container.

WARNING: DO NOT remove the pressure cap on an overheated engine. The coolant is under pressure and relieving the pressure will cause the coolant to flash into steam.

NOTE: If there is adequate coolant in the cooling system, gradual and cooling is preferred by running the engine a half speed. This eliminates hot spots in the engine, and possible failure.

High Water Temperature Checks-Engine Stopped and Cold

1. Check coolant level. Determine if the coolant has proper antifreeze protection. A 50-50 solution of permanent-type antifreeze and approved water will give protection below -200F (-290C).
2. Check to be sure the raw water valve has been opened.
3. Check engine room vents and/or louvers. Be sure the engine is receiving sufficient air.
4. Be sure temperature regulators are operating at proper temperature range.
5. Inspect all water hoses carefully for collapsing, external and internal failures. Replace hoses as required.
6. Have the cooling system cleaned.

CAUTION: If severe or prolonged overheating has occurred, contact your engine dealer to have your engine checked for possible damage.



OPERATION / MAINTENANCE MANUAL

MODEL 475 POWER UNIT

7032 SOUTH 196th - KENT, WA. 98032 - (253) 872-0141 / FAX (253) 872-8710

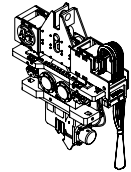

- APPENDIX A - CAT C13 ENGINE

A-2. MAINTENANCE RECOMMENDATIONS

CAUTION: Never add coolant to an overheated engine; allow the engine to cool first.

Cooling

Check specific gravity of antifreeze solution frequently in cold weather to assure adequate protection. Coolant should be drained and replaced "Every 2000 Service Meter Units." With additions of Cooling System Inhibitor or the use of Coolant Conditioner Elements as recommended, the drain period can be extended to "Every 4000 Service Meter Units."

All water is corrosive at engine operating temperature. The cooling system should be protected with inhibitor at all times regardless of concentration of antifreeze. This can be done by maintaining a 3% concentration of liquid Cooling System Inhibitor or by using Coolant Conditioner Elements.

Never use both the liquid cooling system inhibitor and coolant elements at the same time.

Do not use Cooling System Inhibitor or Coolant Conditioner Elements with Dowtherm 209 Full-Fill Coolant.

Whenever draining and refilling cooling system, always recheck the coolant level when the engine reaches normal operating temperature.

Filling at over 5 U.S. gallons (19 liters) per minute can cause air pockets in the cooling system.

Premix antifreeze solution to provide protection to the lowest expected ambient temperature. Pure undiluted antifreeze will freeze at -100F (-23,C).

Operate with a thermostat in the cooling system all year-round. Cooling system problems can arise without a thermostat.

Electrical

CAUTION: When using jumper cables to start the engine, be sure to connect in parallel: POSITIVE (+) to POSITIVE (+) and NEGATIVE (-) to NEGATIVE

Scheduled Oil Sampling

Use scheduled Oil sampling to monitor the engine's condition and maintenance requirements. Each oil sample should be taken when the oil is hot, and well mixed, to insure a sample which is representative of the oil in the compartment.

Consult your engine dealer for complete information, and assistance in establishing a Scheduled Oil Sampling program for your equipment.



OPERATION / MAINTENANCE MANUAL

MODEL 475 POWER UNIT

7032 SOUTH 196th - KENT, WA. 98032 - (253) 872-0141 / FAX (253) 872-8710

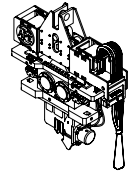

- APPENDIX A - **CAT C13 ENGINE**

A-2. MAINTENANCE RECOMMENDATIONS (Continued...)

Fuel

CAUTION: Fill fuel tank at the end of each day of operation to drive out moisture laden air and to prevent condensation. Do not fill the tank to the brim. The fuel expands when it gets warm and may overflow.

Water and sediment should be drained from the fuel tank at the start of each shift or after the fuel tank has been filled and allowed to stand for 5 to 10 minutes.

Drain fuel tank of moisture and sediment as required by prevailing conditions.

After changing fuel filters, always bleed fuel system to remove air bubbles from system.

Air intake

Service air cleaners when RED band in indicator locks in visible position.

A-2A. LUBRICATION SPECIFICATIONS

Crankcase Lubricating Oils

Use oils which meet Engine Service Classification (MIL-L-2104D) or CD/TO-2. These are additive-type oils that have been approved for use in Diesel Engines.

Consult the "EMA Lubricating Oils Data Book," Form SEBU5939, for a listing of CD oil brands.

The proper SAE grade of oil to select is determined by the ambient temperature at which the engine is started and the maximum ambient temperature in which the engine will be operating.

To determine if the oil in the crankcase will flow in cold weather, remove the oil dipstick before starting. If the oil will flow off, the oil is fluid enough to circulate properly.

Lubricating Grease

Use Multipurpose-type Grease (MPGM) which contains 3-5% molybdenum disulfide conforming to MIL-M-7866, and a suitable corrosion inhibitor. NLGI No.2 Grade is suitable for most temperatures. Use NLGI No. 0 or No. 1 Grade for extremely low temperatures.



OPERATION / MAINTENANCE MANUAL

MODEL 475 POWER UNIT

7032 SOUTH 196th - KENT, WA. 98032 - (253) 872-0141 / FAX (253) 872-8710

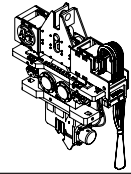

- APPENDIX A - **CAT C13 ENGINE**

A-2. MAINTENANCE RECOMMENDATIONS (Continued...)

A-2B. FUEL SPECIFICATIONS

No. 2 fuel oil and No. 2D diesel fuel are recommended for use in Diesel Engines. In extreme cold temperatures use No. 1 fuel oil or No.1 D diesel fuel.

In selecting a fuel, note that distillate fuels are especially desirable because the fuel is heated to a vaporous state and condensed, thus eliminating all sediment and residue.

A-2C. COOLANT SPECIFICATIONS

Water used in the jacket water cooling system should be clean, and as free as possible from scale forming minerals or corrosive chemicals. Artificially softened water should not be used. Treating the water with Coolant Inhibitor, or equivalent will help prevent the formation of rust and pitting. It will also retard, and in some cases completely eliminate, mineral deposits in the engine.

The most efficient and satisfactory corrosion protection for the cooling system is to maintain proper level of coolant inhibitor and antifreeze solution. The use of auxiliary water filters is not recommended.

During freezing weather use the proper permanent type antifreeze and water solution to prevent freezing.

Before placing the engine in operation, make sure a 3% concentration of Corrosion Inhibitor has been added to the cooling system. This 3% concentration must be maintained in cooling systems which are filled with water and systems protected with ethylene glycol antifreeze mixture, regardless of antifreeze concentration.

WARNING: Inhibitors contain alkali. Avoid contact with eyes. To prevent personal injury, avoid pro-longed or repeated contact with skin.



OPERATION / MAINTENANCE MANUAL

MODEL 475 POWER UNIT

7032 SOUTH 196th - KENT, WA. 98032 - (253) 872-0141 / FAX (253) 872-8710

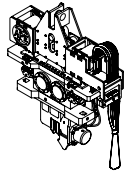

CAT C13 ENGINE

A-2. MAINTENANCE RECOMMENDATIONS (Continued...)

A-2D. LUBRICATION AND MAINTENANCE

The LUBRICATION AND MAINTENANCE CHART lists all serviceable items commonly ordered on this engine. The maintenance tune intervals are expressed in "Operating Hours".

Daily	Weekly	250 Hours or 6 months	1500 Hours or 1 Year	6000 Hours or 2 Years	6000 Hours or 3 Years
<ul style="list-style-type: none"> • Check operator's report • Check and bring to correct level <ul style="list-style-type: none"> - Engine Oil - Coolant • Visually inspect fan. • Visually inspect engine for damage, leaks, loose or frayed belts and correct or record for future action. • Drain fuel-water separator. 	<p>Repeat Daily Check</p> <ul style="list-style-type: none"> • Check air intake system for wear points or damage to piping, loose clamps, and leaks. • Check air cleaner restriction. • Check and clean air cleaner element. • Drain moisture from air tanks. 	<p>Repeat Daily and Weekly Check</p> <ul style="list-style-type: none"> • Change Lubricating Oil. • Change Lubricating Oil Filters. • Change Fuel Filter. • Change Coolant Filter. • Clean Crankcase Breather. • Check engine coolant concentration level. Add make-up if required. • Replace final Fuel Filter/Clean primary Fuel Filter. Drain water from fuel tank. • Inspect/Replace Alternator, Fan and Accessory Drive Belts. • Inspect/Replace Hoses and Clamps. • Lubricate Fan Drive Bearings. • Clean/Check Battery electrolyte level. 	<p>Repeat Previous Intervals</p> <ul style="list-style-type: none"> • Adjust valves and injectors. • Steam clean engine. • Check torque on turbocharger mounting nuts. • Check torque on engine mounting bolts. • Replace hoses as required. • Check/Adjust engine valve lash. • Check/Adjust low idle speed. • Test/Exchange fuel injection nozzles. • Inspect coolant pump. Clean cooling system. (Internal) • Inspect/Rebuild Alternator. 	<p>Repeat Previous Intervals</p> <ul style="list-style-type: none"> • Clean cooling system and change coolant and antifreeze. • Inspect temperature regulator. • Inspect/Rebuild turbocharger. • Inspect/Rebuild starter. • Check and adjust clutch. 	<p>Repeat Previous Intervals Which Are Due</p> <ul style="list-style-type: none"> • Clean and calibrate the following: (Rebuild or exchange if required.) <ul style="list-style-type: none"> - Injectors. - Fuel pump. - Air compressor. - Fan clutch. - Water pump. - Fan hub. - Fan idler pulley assembly. - Vibration damper.

Follow the manufacturer's recommended maintenance procedures for the starter, alternator, generator, batteries, electrical components, engine brake, exhaust brake, air compressor, freon compressor, and fan clutch.
At each scheduled maintenance interval, perform all previous maintenance checks which are due for scheduled maintenance.



OPERATION / MAINTENANCE MANUAL

MODEL 475 POWER UNIT

7032 SOUTH 196th - KENT, WA. 98032 - (253) 872-0141 / FAX (253) 872-8710

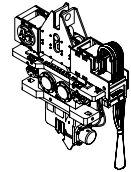

- APPENDIX A - CAT C13 ENGINE

A-2E. ELECTRICAL SYSTEM

The following topics describe care and maintenance of the electrical system components. These components functioning together produce the energy needed for operating the electrical equipment on the engine and each is dependent upon the others for satisfactory operation. In the event of failure or improper operation, it is essential to check the entire electrical system as a defect in one component can cause damage to another. Many electrical system problems can be traced to loose or corroded connections. Keep connections tight and make sure the wiring insulation is in satisfactory condition. Most of the electrical system testing can be performed while the components are on the engine. It should be remembered, if a malfunction is found on test, the component must be removed for further testing, repair or replacement.

Battery

Every 250 hours check the electrolyte level of each cell and the general condition of the battery. Maintain the electrolyte level to the base of each vent well. The make-up water must be one of the following (in order of preference):

1. Distilled water.
2. Odorless, tasteless drinking water-
3. Iron free water.

WARNING: Never add acid or electrolyte.

Cleaning Battery

Mix a weak solution of baking soda and water. Apply the solution with a soft bristle brush. Be careful not to get cleaning solution into the battery. Thoroughly rinse the battery and battery tray with clean water. Apply grease to battery cable clamps and terminals and to all threads.

-Installing Battery

1. Be sure the battery tray is clean and free of foreign objects.
2. Be sure terminal posts and cable clamps are clean.
3. Place the battery in the tray. Tighten the hold down clamps evenly until the battery is snug. Do not over tighten.
4. Connect the "hot" terminal first. Be sure the top of the cable terminal is pushed down even with the top of the terminal post. Tighten the clamp firmly.

WARNING: Always connect the "hot" terminal first to minimize arcing. Otherwise injury or damage could result.

5. Connect the "grounded" terminal last. Be sure the top of the cable terminal is pushed down even with the top of the terminal post. Tighten the clamp firmly.
6. Apply a thin coating of grease over the cable clamps, terminals and hold down fasteners.





OPERATION / MAINTENANCE MANUAL

MODEL 475 POWER UNIT

7032 SOUTH 196th - KENT, WA. 98032 - (253) 872-0141 / FAX (253) 872-8710

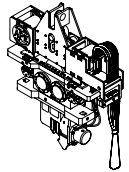

- APPENDIX A - **CAT C13 ENGINE**

A-2E. ELECTRICAL SYSTEM (Continued...)

Charging the Battery

WARNING: Never smoke in the area where batteries are being charged. Hydrogen gas is given off at each vent cap during charging. Hydrogen mixed with air is highly explosive.

1. Connect positive charger clamp to positive battery terminal.
2. Connect negative charger clamp to negative battery terminal.
3. Connect charger power cord to proper outlet.
4. Allow battery to charge slowly.

CAUTION: If battery is charged too rapidly, the battery will be damaged.

5. After the battery is charged, disconnect charger power cord from outlet; remove charger clamp from negative battery terminal; remove charger clamp from positive battery terminal.

A-3. Engine Troubleshooting.

-TROUBLESHOOTING INDEX-

ITEM	PROBLEM	ITEM	PROBLEM
1.	Engine Fails to Start	16.	Valve Lash Close-up
2.	Misfiring	17.	Premature Engine Wear
3.	Stalls at Low Speed	18.	Coolant in Engine Lubricating Oil
4.	Erratic Engine Speed	19.	Excessive Black or Gray Smoke
5.	Low Power	20.	Excessive White or Blue Smoke
6.	Excessive Vibration	21.	Low Engine Oil Pressure
7.	Heavy Combustion Knock	22.	High Lubricating Oil Consumption
8.	Valve Train Clicking Knock	23.	Abnormal Engine Coolant Temperature
9.	Oil in Coolant	24.	Starting Motor Fails to Crank
10.	Mechanical Knock	25.	Alternator Fails to Charge
11.	Excessive Fuel Consumption	26.	Alternator Charging Rate Low or Unsteady
12.	Loud Valve Train Noise	27.	Alternator Charging Rate High
13.	Excessive Valve Lash	28.	Alternator Noisy
14.	Valve Spring Retainer Free		
15.	Slobber		



OPERATION / MAINTENANCE MANUAL

MODEL 475 POWER UNIT

7032 SOUTH 196th - KENT, WA. 98032 - (253) 872-0141 / FAX (253) 872-8710

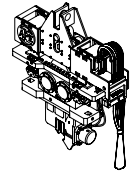

- APPENDIX A - CAT C13 ENGINE

A-3. Engine Troubleshooting. (Continued...)

Possible Causes	Remedy
1. ENGINE FAILS TO START	
No Fuel to Engine	Check for empty fuel tank, plugged fuel tank connections, obstructed or kinked fuel suction lines, fuel transfer pump failure, or plugged fuel filters.
Shutoff Solenoid Sticking*	Solenoid must be energized to shut off engine. Actuate the control that operates the shutoff solenoid and listen for a clicking sound. If clicking sound is not evident and engine will not start, remove the solenoid. Again try to start the engine. If the engine starts, the solenoid is bad. Replace the solenoid.
Fuel Transfer Pump	At cranking speed, the fuel transfer pump should supply fuel to the engine at 3 PSI (20 kPa). If fuel pressure is less than 3 PSI (20 kPa), replace the fuel filter. Check for air in fuel system, sticking, binding or defective fuel bypass valve. If pressure is still low, replace the fuel transfer pump.
Engine Improperly Timed	See your authorized dealer.
Glow Plug Failure	Check glow plugs.
Automatic and Safety Shutoff Controls	Check shutoff controls to ensure they are set properly. See Starting Procedures.
*Optional Equipment	
2. MISFIRING	
Defective Fuel Injection Nozzle or Fuel Pump	Run the engine at the speed where the defect is most pronounced. Momentarily loosen the fuel line nut on the injection pump to "cut out" that cylinder. Check each cylinder in this manner. If one is found where loosening makes no difference in irregular operation, the pump and nozzle for only that cylinder need be treated.
Improper Valve Lash	Set to specified clearance.
Incorrect Fuel Injection Timing	See your authorized dealer.
Low Fuel Supply Pressure	Check fuel supply line for leaks or kinks, air in fuel system, sticking, binding, or defective fuel bypass valve. Replace fuel filter. Check fuel pressure. Fuel transfer pump should supply fuel at 20 to 30 PSI (1.4 to 2.1 kg/cm ²) to the engine when the engine is fully loaded.
Broken or Leaking High Pressure Fuel Line	Replace the line.
Air in Fuel System	Find source of air entry and correct. Bleed system.
Bent or Broken Push Rod	Replace push rod.



OPERATION / MAINTENANCE MANUAL

MODEL 475 POWER UNIT

7032 SOUTH 196th - KENT, WA. 98032 - (253) 872-0141 / FAX (253) 872-8710

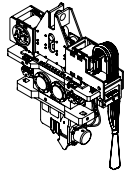

- APPENDIX A - CAT C13 ENGINE

A-3. Engine Troubleshooting. (Continued...)

Possible Causes	Remedy
4. ERRATIC ENGINE SPEED	
Governor Control Linkage	Adjust external linkage to obtain sufficient travel. Replace if damaged, bent, or linkage is too short.
Governor Failure	Look for damaged or broken springs, linkage, or other components. Determine if the rack can be moved manually. If any distress is noted in any of these components, replace as necessary.*
5. LOW POWER	
Fuel Nozzle Failure	Run the engine at the speed where the defect is most pronounced. Momentarily loosen the fuel line nut on the injection pump to "cut out" that cylinder. Check each cylinder in this manner. If one is found where loosening makes no difference in irregular operation, the pump and nozzle for only that cylinder need be tested.
Poor Quality Fuel	Drain, clean and bleed fuel system. Replace fuel filter. Fill fuel tank with proper grade of fuel.
Turbocharger Carboned or Otherwise Dragging	Inspect and repair or replace turbo charger as necessary.*
Leaks in Air Induction System	Check inlet manifold pressure. Check air cleaner for restriction.
Incorrect Fuel Injection Timing	See your authorized dealer.
Excessive Valve Lash	Set to specified clearance.
Low Fuel Supply Pressure	Check fuel supply line for leaks or kinks, air in fuel system, sticking, binding or defective fuel bypass valve. Replace fuel filter. Check fuel pressure. Fuel transfer pump should supply fuel to 20 to 30 PSI (1.4 to 2.1 kg/CM ²) to the engine when the engine is fully loaded.
6. EXCESSIVE VIBRATION	
Loose, Worn or Defective Engine Mounts as necessary.	Tighten all mounting bolts securely. Replace components
Loose Pulley and Damper	Re tighten.
Loose or Worn Coupling on Driven Equipment	Inspect, align and tighten coupling to driven equipment.
Defective Damper or Pulley	Replace damper or pulley.
Misfiring	See ITEM 2.



OPERATION / MAINTENANCE MANUAL

MODEL 475 POWER UNIT

7032 SOUTH 196th - KENT, WA. 98032 - (253) 872-0141 / FAX (253) 872-8710

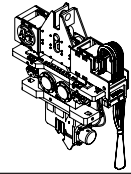

- APPENDIX A - CAT C13 ENGINE

A-3. Engine Troubleshooting. (Continued...)

Possible Causes	Remedy
7. HEAVY COMBUSTION KNOCK	
Air in Fuel System	Bleed air from system.
Defective Fuel Injection Pump Plunger and Barrel Assembly	Replace.*
Defective Fuel Injection Nozzle	Replace.
Incorrect Fuel Injection Timing	See your authorized dealer.*
8. VALVE TRAIN CLICKING NOISE	
Excessive Valve Lash	Set to specified clearance.
Broken Valve Spring(s)	Replace valve spring(s) and all other damaged components.*
Insufficient Lubrication	Check lubrication in valve compartment. Should be very wet at all speeds. Oil passages should be cleaned, especially those leading to the cylinder head.
9. OIL IN COOLANT	
Failed Oil Cooler Core	Replace oil cooler core.
Failed Head or Spacer Plate Gaskets	Replace head and spacer plate gaskets.
Cracked or Defective Cylinder Block	Replace cylinder block.*
Cracked or Defective Head	Replace cylinder head.
10. MECHANICAL KNOCK	
Engine Connecting Rod Bearing Failure	Replace the bearing. Check the connecting rod and crankshaft. Replace if necessary.*
Main Bearing Failure	Replace bearings.*
Damaged Timing Gear Train	Replace components as necessary.*
Broken Crankshaft	Replace crankshaft.*
Fuel Dilution of Crankcase Oil	Correct fuel leakage into crankcase oil.

*Authorized dealers are equipped with the necessary tools and personnel familiar with disassembly procedures to perform these services.



OPERATION / MAINTENANCE MANUAL

MODEL 475 POWER UNIT

7032 SOUTH 196th - KENT, WA. 98032 - (253) 872-0141 / FAX (253) 872-8710

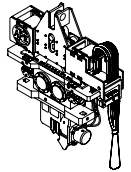

- APPENDIX A - CAT C13 ENGINE

A-3. Engine Troubleshooting. (Continued...)

Possible Causes	Remedy
11. EXCESSIVE FUEL CONSUMPTION	
Fuel System Leaks	Large changes in fuel consumption may result. Internal leaks will probably be accompanied by low engine oil pressure and increased oil level in the engine oil sump. Replace leaking components.
Fuel and Combustion Knock	Small but measurable increases in fuel consumption maybe the result of defective fuel nozzles, misfiring or factors contributing to loss of power. See ITEM 2 and ITEM 5.
Incorrect Fuel Injection Timing	See your authorized dealer.
12. LOUD VALVE TRAIN NOISE	
Bent or Broken Valves	Replace damaged parts.*
Broken Camshaft	Replace all damaged parts. Clean engine thoroughly.
Broken or Severely Worn Valve Lifters	Replace camshaft and valve lifters. Check for sticking valves and bent valve stems. Clean engine thoroughly. Set valve lash to specified clearance.
13. EXCESSIVE VALVE LASH	
Severely Worn Cam Lobes	Check valve lash. Replace camshaft and followers. Clean engine thoroughly. Set valve lash to specified clearance.
Broken or Severely Worn Valve Lifters	Replace valve lifters. Check camshaft for wear. Check for sticking valves and bent valve stems. Clean engine thoroughly. Set valve lash to specified clearance.
Valve Tip Wear	Set valve lash to specified clearance. If wear is excessive, replace valve. Moderate Valve Lifter Face Wear Set valve lash to specified clearance. If wear is excessive, replace valve lifter.
Push Rod Wear	Set valve lash to specified clearance. If wear is excessive, replace push rod.
Rocker Arm Anvil Wear	Set valve lash to specified clearance. If wear is excessive, replace rocker arm.
Insufficient Lubrication	Check lubrication in valve should be very wet at high idle speeds, but only damp at low idle. Oil passages should be cleaned, especially those leading to the cylinder head.





OPERATION / MAINTENANCE MANUAL

MODEL 475 POWER UNIT

7032 SOUTH 196th - KENT, WA. 98032 - (253) 872-0141 / FAX (253) 872-8710

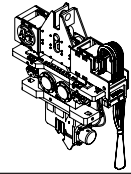

- APPENDIX A - CAT C13 ENGINE

A-3. Engine Troubleshooting. (Continued...)

Possible Causes	Remedy
14. VALVE SPRING RETAINER FREE	
Broken Keepers	Extensive engine damage may result from dropped valve. Replace all damaged parts.*
Broken Valve Spring	Replace valve spring.*
Broken Valve	Replace valve and any other damaged parts.*
15. SLOBBER	
Excessive Valve Guide Wear	Recondition cylinder head assembly.*
Excessive Lubricating Oil in Valve Compartment in place.	Check rocker arm shaft and plugs to assure that they are
Worn Piston Rings and/or Liners	Inspect and replace components as necessary.*
16. VALVE LASH CLOSE-UP	
Valve Face and/or Seat Wear	Adjust valves to specified clearance. Recondition cylinder head.
17. PREMATURE ENGINE WEAR	
Intake Piping Failure (Air Cleaner)	Inspect all gaskets and piping for leaks. Repair all leaks.
Excessive Fuel Dilution of Lubricating Oil	Replace leaking components. This will probably be accompanied by high fuel consumption and low engine oil pressure. Tighten fuel injection line fittings under valve cover.
Dirt in Lubricating Oil	Locate and correct source of dirt entry, Change lubricating oil. Change oil filter.
18. COOLANT IN ENGINE LUBRICATING OIL	
Oil Cooler Failure	Replace oil cooler core.
Cylinder Head Gasket Failure	Replace gasket. Maintain proper torque on cylinder head bolts.
Cracked or Defective Cylinder Head	Replace cylinder head.*
Cracked or Defective Cylinder Block	Replace cylinder block.*

*Authorized dealers are equipped with the necessary tools and personnel familiar with disassembly and assembly procedures to perform these serviced.





OPERATION / MAINTENANCE MANUAL

MODEL 475 POWER UNIT

7032 SOUTH 196th - KENT, WA. 98032 - (253) 872-0141 / FAX (253) 872-8710

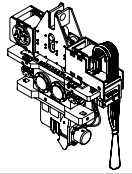

- APPENDIX A - CAT C13 ENGINE

A-3. Engine Troubleshooting. (Continued...)

Possible Causes	Remedy
18. COOLANT IN ENGINE LUBRICATING OIL (Cont'd)	
Cylinder Liner Seal Leaking	Replace seals.*
Cracked or Defective Cylinder Liners	Replace cylinder liners.†
19. EXCESSIVE BLACK OR GRAY SMOKE	
Insufficient Combustion Air	Check air cleaner for restriction. Check inlet manifold pressure. Inspect turbocharger for proper operation.
Fuel Nozzle Plugged or Leaking	Replace nozzle.
Incorrect Fuel Injection Timing	See your authorized dealer.
Fuel Ratio Control Improperly Adjusted	Adjust fuel ratio control.*
20. EXCESSIVE WHITE OR BLUE SMOKE	
Valve Guides Worn	Recondition cylinder head assembly.*
Piston Rings Worn, Stuck or Broken	Replace.*
High Crankcase Oil Level	Avoid overfilling. Determine cause and drain excess oil.
Misfiring	See ITEM 2.
Fuel Injection Pump Timing Wrong	See your authorized dealer.
Air in Fuel System	Bleed fuel system.
21. LOW ENGINE OIL PRESSURE	
Engine Oil Diluted with Fuel Oil	Check lip-type seal on fuel transfer pump drive shaft. Drain crankcase and refill with clean lubricant.
Excessive Crankshaft Bearing Clearance	Replace bearings and/or crankshaft.* Check oil filter operation.
Excessive Timing Gear Bearing Clearances	Inspect bearings and replace components as necessary.
Excessive Rocker Arm Bore or Rocker Arm Shaft Wear	Check lubrication. Replace components as necessary.
Defective Oil Pump	Repair or replace.*
Defective Suction Bell	Replace.



OPERATION / MAINTENANCE MANUAL

MODEL 475 POWER UNIT

7032 SOUTH 196th - KENT, WA. 98032 - (253) 872-0141 / FAX (253) 872-8710

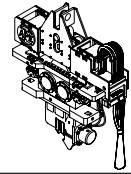

- APPENDIX A - **CAT C13 ENGINE**

A-3. Engine Troubleshooting. (Continued...)

Possible Causes	Remedy
21. LOW ENGINE OIL PRESSURE (Cont'd)	
Clogged Oil Filter or Cooler	Repair or replace as necessary.
Oil Pump Relief Valve Stuck	Clean valve and housing. Replace if necessary.
22. HIGH LUBRICATING OIL CONSUMPTION	
Oil Leaks	Replace gaskets or seals and tighten all connections.
Excessive Oil to Intake	See ITEM 15. Valve Guides.
Excessive Valve Guide Wear	See ITEM 15.
Crankcase Oil Level Too High	Avoid overfilling. Determine cause and drain excess oil.
High Oil Temperature	Check oil cooler bypass valve. Replace if defective. Clean oil cooler core.
Worn Piston Rings and/or Liner	Replace components as necessary.*
23. ABNORMAL ENGINE COOLANT TEMPERATURE	
Combustion Gases in Coolant	Determine point at which gases enter the system. Repair or replace components as necessary.
Defective Water Temperature Regulator or Temperature Gauge	Check temperature regulator for proper opening temperature and correct installation. Check temperature gauge. Replace if necessary.
Coolant Level Low	Determine cause-replace leaking gaskets and hoses. Tighten connections. Add coolant.
Air Flow Through Radiator Restricted	Remove all debris from outer surface of radiator.
Defective Water Pump	Check water pump impeller. Repair water pump as necessary.
Radiator Small for Engine Application	Install correct size radiator.
Fan Improperly Positioned in Shroud or Not Shrouded	Position fan correctly.*

*Authorized dealers are equipped with the necessary tools and personnel familiar with disassembly and assembly procedures to perform these serviced.



OPERATION / MAINTENANCE MANUAL

MODEL 475 POWER UNIT

7032 SOUTH 196th - KENT, WA. 98032 - (253) 872-0141 / FAX (253) 872-8710

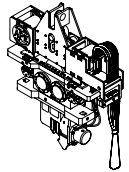

- APPENDIX A - CAT C13 ENGINE

A-3. Engine Troubleshooting. (Continued...)

Possible Causes	Remedy
23. ABNORMAL ENGINE COOLANT TEMPERATURE	
Incorrect Fuel Injection Timing	See your authorized dealer.
Incorrect Water Piping Connections from Engine to Radiator	Check shunt line (if equipped) and vent line for correct installation.
24. STARTING MOTOR FAILS TO CRANK	
Low Output from Battery	Check battery and charge or replace.
Defective Wiring or Switch	Repair or replace.
Defective Solenoid	Replace.
Defective Starting Motor	Repair.
25. ALTERNATOR FAILS TO CHARGE	
Drive Belt Loose	Adjust belt.
Open or High Resistance in Charging or Ground Return Circuits or Battery Connections	Inspect all cables and connectors. Clean, re tighten or replace defective parts.
Excessively Worn, Open or Defective Brushes	Replace brush assembly.*
Open Rotor Field Coil	Replace rotor assembly.*
26. ALTERNATOR CHARGING RATE LOW OR UNSTEADY	
Drive Belt Loose	Adjust belt.
Intermittent or High Resistance in Charging or Ground Return Circuits or Battery Connections	Inspect all cables and connectors. Clean, re tighten or replace defective parts.
Excessively Worn, Sticky, or Defective Brushes	Replace brush assembly.*
Faulty Regulator	Replace regulator.*
Shorted or Open Rectifier Diodes	Replace defective rectifier diode assembly in alternator.*
Grounded or Shorted Rotor	Replace rotor assembly.*



OPERATION / MAINTENANCE MANUAL

MODEL 475 POWER UNIT

7032 SOUTH 196th - KENT, WA. 98032 - (253) 872-0141 / FAX (253) 872-8710

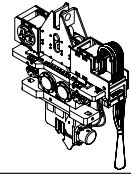

- APPENDIX A - **CAT C13 ENGINE**

A-3. Engine Troubleshooting. (Continued...)

Possible Causes	Remedy
27. ALTERNATOR CHARGING RATE HIGH	
Loose Connections	Tighten connections to alternator and regulator.
Defective Regulator	Replace regulator.
28. ALTERNATOR NOISY	
Defective Drive Belt	Replace belt.
Misaligned Belt or Pulley	Align drive pulley, alternator pulley and belt.
Loose Pulley	Tighten pulley nut. If keyway is worn, install a new pulley.
Worn Bearings	Replace bearings.
Shorted Rectifiers in Alternator	Replace diode assembly.*
Armature or Rotor Shaft Bent	Replace component.*

*Authorized dealers are equipped with the necessary tools and personnel familiar with disassembly and assembly procedures to perform these serviced.





OPERATION / MAINTENANCE MANUAL

MODEL 475 POWER UNIT

7032 SOUTH 196th - KENT, WA. 98032 - (253) 872-0141 / FAX (253) 872-8710

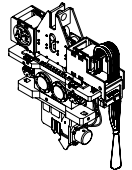

NOISE LEVEL OF APE MODEL 475 POWER UNIT

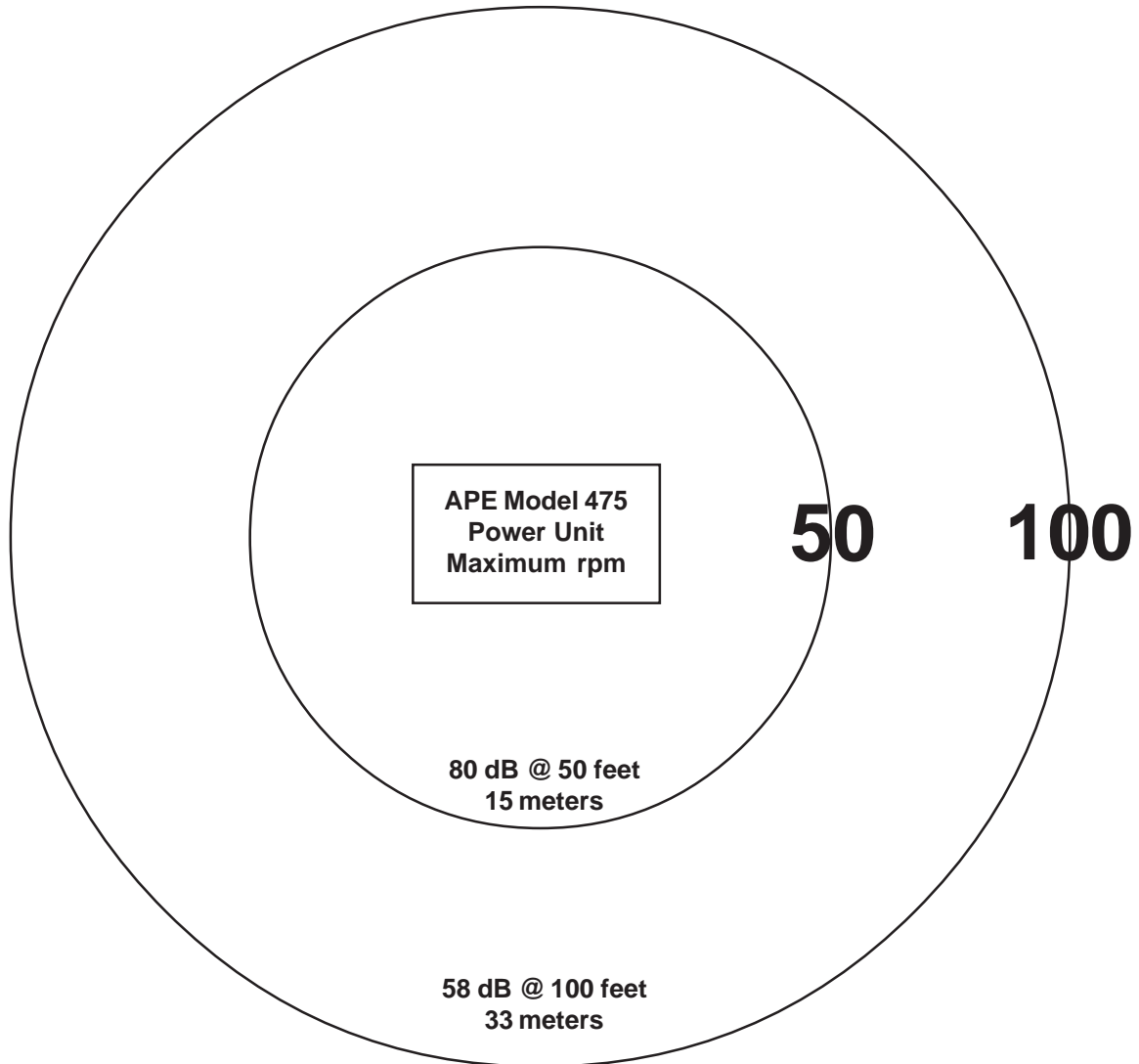

Note: Decibel level can be further reduced by operating at a lower engine rpm. The above chart is based on the power unit at full rpm. In most cases, it is not necessary to run the engine at full rpm to drive or extract piles or when using the power unit for drilling operations.

